



ST. FRANCIS INSTITUTE OF TECHNOLOGY

IRIS 2016



आमची

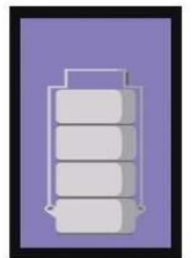
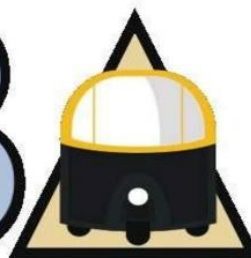

VISION

“To be a CHRYSLIS WHERE BRIGHT YOUNGSTERS ARE TRANSFORMED INTO TECHNOLOGICAL ENTREPRENEURS AND INNOVATIVE LEADERS OF TOMORROW’S WORLD, CONSISTENT WITH THE FRANCISCAN VISION OF INTEGRITY, PEACE AND LOVE.”

MISSION

FOR UG PROGRAMME:- “To churn highly competent engineering graduates with a commitment to result oriented work, a perennial zest for learning, a quest for excellence, an open mind and the universal values of honesty, dignity and mutual care.”

FOR PG PROGRAMME:- “To continually improve and progress in the path of developing post graduate scholars who will be competent in exploring, developing and disseminating new knowledge in their areas of specialization so that the repository of new knowledge and innovation and its dissemination will be enhanced in scope of effectiveness.”



St. Francis Prayer

Lord, make me an instrument of Your peace.

Where there is hatred,

Let me sow love;

Where there is injury, pardon;

Where there is doubt, faith;

Where there is despair, hope;

Where there is darkness, light;

Where there is sadness, joy.

O, Divine Master, grant that

I may not so much seek

To be consoled as to console;

To be understood as to understand;

To be loved as to love;

For it is in giving that we receive;

It is in pardoning that we are pardoned;

It is in dying that we are born again to eternal life.

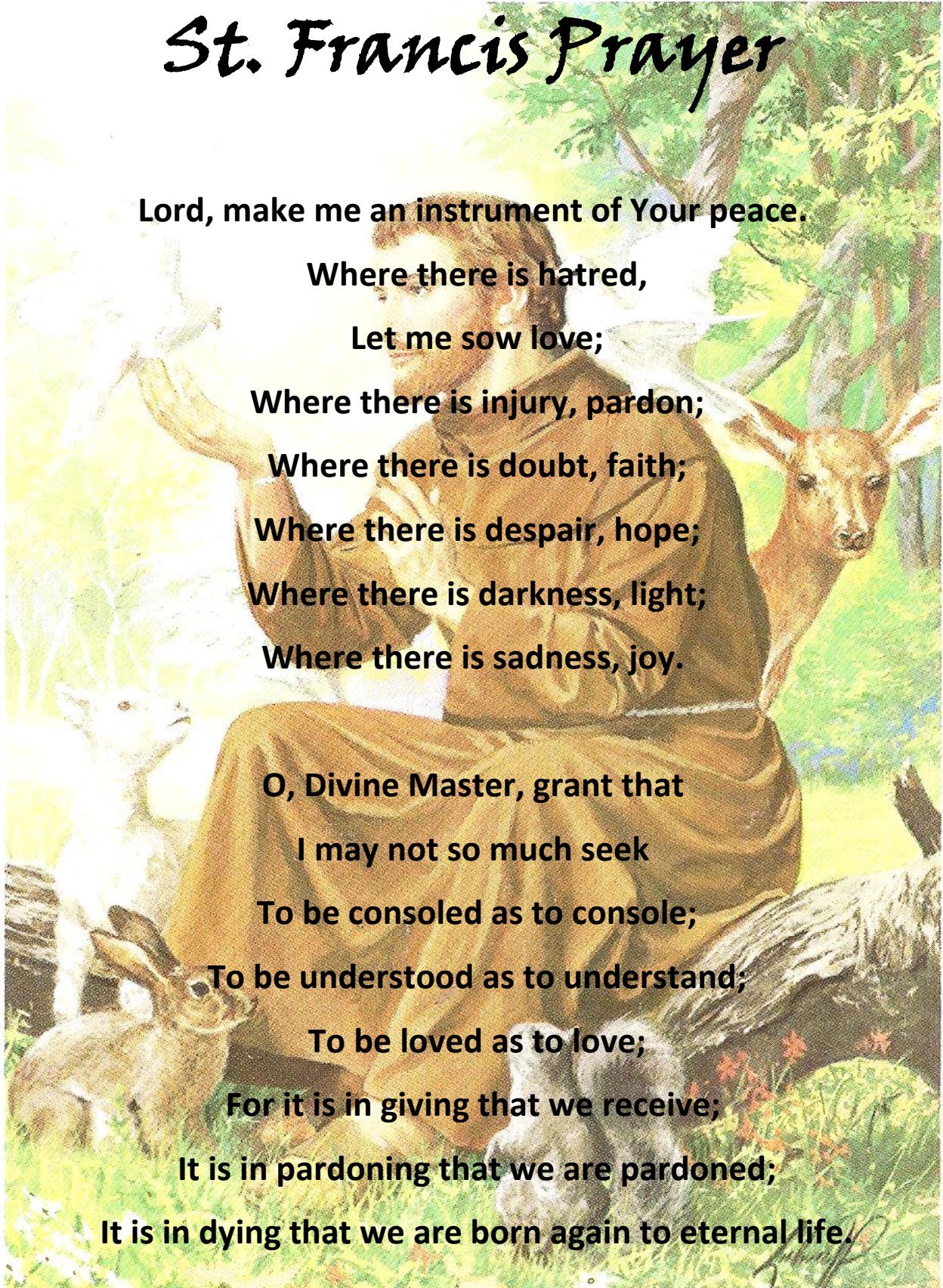

EXECUTIVE COMMITTEE



Rev. Bro. Jose Valliara,
CMSF



Bro. Mathwe Thekkemury
Administrator



Bro. Melchior Tom
Director



Bro. Jose K.S.
Dy. Director



Bro. Mathew PJ
Member



Bro. Vijaykumar Pereira
Member



Bro. Alphonse Nesamony
Member



Mr. Augustine Kurias
Member



Mr. Albert D'Souza
Member



Dr. Thomas Mathew
Member



GOVERNING COUNCIL

- | | | |
|-----------------------------|---|------------------------------|
| 1. Bro. Jose Valliara | - | Chairman |
| 2. Bro. Mathew Thekkemury | - | Campus Administrator |
| 3. Bro. Melchior Tom | - | Director, Member |
| 4. Bro. Jose K. S. | - | Dy. Director, Member |
| 5. Bro. Vijaykumar Pereira | - | Member |
| 6. Bro. Alphonse Nesamony | - | Member |
| 7. Dr. Thomas Mathew | - | Member |
| 8. Prof. Dr. S.N. Merchant | - | Member |
| 9. Prof. Dr. Ancy Jose | - | Member |
| 10. Shri Abhijit Talukdar | - | Member |
| 11. Adv. Yogesh Naidu | - | Member |
| 12. Dr. S. Krishnamoorthy | - | Member |
| 13. Dr. B. K. Lande | - | Member |
| 14. Dr. Sharad Y. Mhaiskar | - | Member |
| 15. Shri Augustine Kurias | - | Special Invitee |
| 16. Shri Albert D' Souza | - | Special Invitee |
| 17. Shri. Mrinmoy Chaudhury | - | Special Invitee |
| 18. Dr. A. K. Sen | - | Principal - Member Secretary |

LOCAL MANAGING COMMITTEE

- | | | |
|-----------------------------|---|-----------------------------|
| 1. Bro. Jose Valliara | - | Chairman |
| 2. Bro. Mathew Thekkemury | - | Administrator |
| 3. Bro. Melchior Tom | - | Director, Member |
| 4. Bro. Vijaykumar Pereira | - | Member |
| 5. Dr. Gautam Shah | - | Member |
| 6. Ms Bidisha Roy | - | Member |
| 7. Mr. Pramod Shanbhag | - | Member |
| 8. Dr. Poonam Hemnani | - | Member |
| 9. Ms Sally John | - | Member |
| 10. Bro. Jose K.S. | - | Special Invitee |
| 11. Bro. Mathew P.J. | - | Special Invitee |
| 12. Shri Augustine Kurias | - | Special Invitee |
| 13. Shri Albert D'Souza | - | Special Invitee |
| 14. Shri. Mrinmoy Chaudhury | - | Special Invitee |
| 15. Dr. A. K. Sen | - | Principal, Member Secretary |



Academic Advisory Council

- | | | |
|-------------------------|---|-----------------------------|
| 1. Bro. Melchior Tom | - | Chairman |
| 2. Dr. Thomas Mathew | - | Member |
| 3. Mr. Albert D'Souza | - | Member |
| 4. Dr. S.N. Merchant | - | Member |
| 5. Dr. S. Biswas | - | Member |
| 6. Dr. B.K. Lande | - | Member |
| 7. Mr. Lester Fernandes | - | Member |
| 8. Dr. A. K. Sen | - | Principal, Member Secretary |
| 9. Dr. Deepak Jayaswal | - | Member |
| 10. Dr. Gautam Shah | - | Member |
| 11. Mr. Pramod Shanbhag | - | Member |
| 12. Ms. Bidisha Roy | - | Member |
| 13. Dr. Poonam Hemnani | - | Member |
| 14. Dr. Uday P. Khot | - | Special Invitee |
| 15. Dr. Vikram Shete | - | Special Invitee |
| 16. Dr. C. Hariprasad | - | Special Invitee |
| 17. Dr. Kavita Sonawane | - | Special Invitee |
| 18. Dr. Kevin Noronha | - | Special Invitee |
| 19. Dr. Joanne Gomes | - | Special Invitee |
| 20. Mr. M. Chaudhury | - | Special Invitee |

SCREENING COMMITTEE

- | | | |
|---------------------------|---|----------|
| 1. Bro. Melchior Tom | - | Chairman |
| 2. Bro. Jose K. S. | - | Member |
| 3. Dr. A. K. Sen | - | Member |
| 4. Dr. Sharad Y. Mhaiskar | - | Member |
| 5. Dr. B. K. Lande | - | Member |
| 6. Dr. Gautam Shah | - | Member |
| 7. Ms. Bidisha Roy | - | Member |
| 8. Mr. Pramod Shanbhag | - | Member |
| 9. Dr. Poonam Hemnani | - | Member |



INDEX

DIRECTOR'S MESSAGE.....	09
DEPUTY DIRECTOR'S MESSAGE.....	11
FROM THE PRINCIPAL'S DESK.....	13
EDITORIAL-THE STENTORIAN.....	18
THE EDITORIAL TEAM.....	21
THE STENTORIAN TEAM.....	20
JEDI'S REPORT.....	22
STUDENT COUNCIL'S REPORT.....	23
ARTICLES.....	24
FE DEPARTMENT.....	75
CMPN DEPARTMENT.....	85
EXTC DEPARTMENT.....	92
IT DEPARTMENT.....	102

FROM THE DESK OF THE DEAN ME PROGRAMME.....	111
LIRC.....	116
SRC AND NSS.....	122
ISTE STTP.....	125
NEW DIMENSIONS.....	127
TRAINING & PLACEMENT CELL	129
TOPPERS LIST.....	132
TECHNICAL SECTION.....	140
STUDENTS CHAPTERS & CLUBS GALLERY.....	174



Director's Message



“IRIS”, an SFIT annual extravaganza - a festival every SFITian looks forward to! It is IRIS – 16. In fact, this year, unlike earlier years, the students’ council had set-in motion preparations well-in-advance, by 2nd week of December; a clear sign how thrilled the SFITians are to usher in the annual college fest - a time to unwind, a time to show case talents, a time to showcase innovative ideas, a time to make and cement friendships, etc.

These college festivals are opportunities, platforms which help one to grow and mature into future professionals, industry leaders and entrepreneurs. In the past, those who had wholeheartedly participated in these events, had enhanced their personality, became more confident people, developed leadership qualities and communicative skills, etc. All these without, least faltering in their academic! It’s wonderful to see, how young boys and girls shape up, who were just childish, bookish have become more focussed, determined and ambitious!

For these ambitious youngsters, industry stalwarts like Steve Job (Apple), Jack Ma (Alibaba. Com), Vijay Shekar Sharma (Paytm), Kunal Bahl (Snapdeal), and many more such entrepreneurs, who are all from humble origins, were or are in their twenties or early thirties and from our own generation, too are their role models.

No wonder then that our very own SFITians (2nd years/3rd years) are daring to venture into their own little businesses/start-ups

Great! However, they need to harness their patience, perseverance, commitment and be focussed to achieve their goal, and I am sure that they will! I would urge these young people to read, more and more of the life stories of their heroes/role-models along with their academic, besides actively participating as engines/dynamos of such college events. These are opportunities one can't afford to miss while in college!

One thing common to all the above mentioned entrepreneurial heroes, is their belief, that the ***“future belongs to those who can think differently and create products and services that people can use in the future.”*** In order, our young people achieve this goal, there needs to have a paradigm shift in our teaching and learning process and this shift, according to Confucius is to be to an experiential learning. That is, “I hear and I forget, I see and I remember, I do and I understand. It is called, 70/20/10 model. 70/20/10 suggests that learners learn 70% through experiences /by doing, 20% through interaction and 10% through formal classroom methods.” How true it is! Because, those great scientists and entrepreneurs, like Thomas Alva Edison, Steve Job, Henry Ford, Bill Gates, Mark Zuckerberg (Facebook), Larry Ellison (Oracle), Elizabeth Holmes (Theranos), Azim Premji (Wipro), Subash Chandra Goel (Zee TV) and many more, though had missed out, partially or fully on the 10% through formal education had made it rich. But they made it rich by working faithfully on the 70/20, and thus became great role-models for you and me!

Let college events and programs, like IRIS, Mosaic, Robocon, E-Cell activities, R&D, etc. be opportunities/platforms for every SFITian that offers the 70/20 to groom and develop into industry leaders/entrepreneurs, which is what the “Vision” of SFIT is! I wish the IRIS-16 and its organizers all the success!

-Br. Melchior Tom





Deputy Director's Message



Ushering in the new year, becomes celebratory and enthusiastic as all of us gear up for the most awaited event of the year –IRIS.It has always has brought out the cultural richness and diversity of our students to the forefront by encouraging the talents of the budding engineers in music, dance, drama, literature and art.Today we explore about the richness of our place and the importance of the one's own living. Mumbai as a whole a metropolitan city where millions of people live and search for the job. Mumbai always known for its diversity of its culture and languages, mixed group of people. Etc.

The city of Bombay originally consisted of seven islands, Mazagoan, Parel, Mattuga-Sion, Old Womens Island, Wadala and Mahim. Later on the name officially changed to Mumbai. The city of Mumbai came in light in the year 150 AD. Mumbai is a city called island city. The seven island that form Mumbai as far as back in 2nd century. Mumbai today is India's financial powerhouse. Asias biggest slums are existing earlier onward. The most prolific film industry is here in this city. Mumbai is one of the most happening cities in India. It is the LAS Vegas of India. Mumbai is known as much as for its throbbing nightlife.

Mumbai has its own culture, traditions and festivals. The busy Mumbai city is economically prosperous and is dubbed as the commercial capital of India. Suburban train network is a lifeline for mumbaikers. Mumbai city comes to a screeching halt during the Ganesh Chaturthi festival. The Gateway of India is tourist attraction whoever visit this place. Shrine of Mount Mary Church Bandra, Worli Sea Link, Vipasana Pagoda are few places to see

People those who come from everywhere, from all parts of the India are become part and parcel of this beautiful city. It accommodates all weather rich or poor. Thousands of people have realized their dreams. Any person who comes can reach their goal if he or she works with courage and strong will in this great city. It is a great moment to celebrate that we too became as part of this beautiful city through our educational endeavours.

The Society of Franciscan Missionary Brothers came to existence in the year 1901, in Mumbai –Borivli. As a first step towards imparting education to the poor and downtrodden children of the society, we started an Orphanage and Technical institute. And another many Institutions for the academical and technical skills where in thousands of children acquire knowledge and thus self-employed and become great entrepreneurs.

Each day Mumbai remains stronger in the midst of any terror attacks and natural calamities. Let us then keep our earnest spirit of working together for bright future of our place wherever we are. I extend my gratitude and salute Mumbai for remaining vibrant location and wish you all success for the IRIS 16 all the best. Thank you.

-BRO.JOSE, K.S.CMSF





From the Principal's Desk



Another year has passed which means another issue of IRIS and a time to report our landmark achievements of the year 2014-15 in every sphere of our activity.

Similar to the previous years, this Academic year (2014-15) also our students have excelled in the academic front. In B.E. examination, we have attained 99.32% result in Electronics & Telecommunication Engineering, 98.65% result in Computer Engineering and 98.09% result in Information Technology. In M.E examination, we have attained 83.33% result in Electronics & Telecommunication Engineering and 100% result in Computer Engineering. The result of our first year engineering examination was 64.99% that enabled us to place in the top six among 65 engineering colleges under Mumbai University. This has been possible due to our strong team of highly qualified faculty, diligent students and dedicated staff. We are also known for our discipline, academic rigor and excellence, research contributions, and industry interface. With this strength we have been able to achieve our goals and able to set new milestones.

Following the trend of last year's our students have participated in 'ABU ROBOCON'- an International level Asia-Pacific Robot Competition held at M.I.T., Pune. We have a Robotics Laboratory stabilised under the guidance of IIT Bombay e-Yantra team. Our under-graduate students from SE and TE participate in e-Yantra competitions organized by IIT Bombay. This Robotics activity is supervised by one of our faculty members who instructs and motivates students to hone their skills in the field of robotics.

The placement record of SFIT is highly commendable. Thanks to the Training & Placement Department's career counselling, support and placement co – ordination activities. This has helped us to achieve excellent recruitment and have helped our students to reach their target. In the academic year 2014-15 more than 50 nos. of industries have visited our institute for campus recruitments and 253 nos. of students were placed out of 268(94.5%). 50 nos. of students have gone abroad for further studies.

Top level IT companies that recruited our students are M/S TCS, L & T InfoTech, Cap Gemini, IBM, MAQ Software, I Gate, Tech Mahindra, Atos Origin, Hexaware, and Mindcraft.

Our students have not only made us proud by their excellent academic performance but have placed our Institute in a dominant position in Sports. The Institute's Basketball, Table Tennis, Chess, Badminton, Football, Cricket, Swimming, and Volleyball teams have participated in various sports events at the University level, State level and National level (MIT college tournament). Our Table Tennis team reached Quarter Finals at MIT -Pune tournament. Our Football team reached the second round at MIT-Pune. Our swimming team secured 4th place in the team event and 5th and 7th position in free-style at MIT-Pune. Our Chess team reached the 5th stage at MIT-Pune. Our Institute hosted an inter-college technical festival "MOSAIC 2015" which received an over-whelming response from all. Chapters like Institute of Electrical and Electronics Engineering (IEEE), Computer Society of India (CSI), Institution of Electronics and Telecommunication Engineers (IETE), Information Technology Students Association (ITSA) and Indian Society for Technical Education (ISTE) arranged industrial visits for the students to Haridwar, Rishikesh, Dehradun, Jim corbet, Manali, Dharmasala, Amritsar, Chandigarh, New Delhi, Mahul, Pune and Lavasa. These activities covered technical, social & subject matters of their interest.

To pursue our goal in the direction of innovation & research and to develop thinking skill of staff and students, our R&D Centre is working continuously under the guidance of an experienced Professor. We have completed twelve R&D projects since the inception of our R&D Centre. In the academic year 2013-14, we have received two minor research grants and in 2014-15, we received six minor research grants from University of Mumbai. In 2015-16, we have applied for seven more minor research projects to Mumbai University. We are also working on research projects based on Aakash Tablets developed by IIT Bombay. In this regard, we have received a research grant from IIT Bombay for four Research Projects in 2014-15. We have organized more than 5 workshops in association with IIT Bombay and IIT Kharagpur for the technical development of our faculty in 2014-15. We are in process of undertaking few consultancy projects in association with industries.

Thus our Institute has taken a major role in implementing the objective of the National Mission on Education through Information and Communication Technology (ICT) funded by the MHRD, Government of India for empowerment of student and teachers through synchronous and asynchronous instruction by becoming the Remote Centre to conduct workshop organized by IIT, Mumbai and Kharagpur. For developing entrepreneurial traits/culture among our students we have formed an Entrepreneurship Cell (E Cell) in the college. The E Cell works in close conjunction with the National Entrepreneurship Network (NEN) – a nationwide organization for developing and sustaining entrepreneurship culture in the campus. SFIT students have founded/co-founded 4 start-ups. Quite a few alumni also have chosen entrepreneurship as their career path. The E Cell is committed to support SFIT student and Alumni start-ups. We urge all stake holders to get actively involved in our activities. Our in-house Technical Magazine ‘Sanshodhan’, published once in a year showcases the research capability of our staff and students. Faculty and students of our Institute have published and presented several papers in Journals and Conferences in this Academic year.

We have published a Research and Development Information Brochure “research” in 2014-15 which gives information about our faculty and their areas of research interest through which we are focussing on some consultancies and research projects from society and industry. Our Faculty members also participated in the workshop for the development of Robotics Laboratory of our College with the guidance of E- Yantra Robotics team of I.I.T, Mumbai.

St. Francis Institute of Technology has one of the best Library facilities known as the Learning & Information Resource Centre (LIRC) located on the second floor. Our LIRC aids the teaching, learning and research related activities of the institute using the best information resources and innovative services. It offers rich collections in tangible and digital formats across the broad spectrum of disciplines represented at SFIT. These collections are not only used by members of the campus, but they are also accessible to all the ACCMI Institutes under the Resource Sharing facility.

The LIRC has over 23,000 books on various aspects of engineering studies. In addition, the library boasts of over 50 journals in print form and more than 2000 e-journals available through online databases.

The library also has varied collection of Audio Visual materials in the form of Audio- Video Cassettes, CDRoms and DVDs. It subscribes to 7 online databases that provide access to nascent and scholarly information.

Our LIRC is also a member of the following:

IIT Library, Bombay: Access to the library of IIT Bombay is provided to the students for three days consecutively after approval from the library.

DELNET (Developing Library Network): It is supported by the National Informatics Centre, Department of Information Technology, Ministry of Communications and Information Technology, Government of India and the Ministry of Culture, Government of India. It offers resource sharing facilities by providing access to books not available in the SFIT library.

In a step towards up gradation of our faculty, fifteen of our faculty members have been sponsored for Ph.D. program and three for M.E program in well-known centres of Science & Technology in India. We have sponsored 53 faculty members for higher studies since inception of the Institute. As of now four of our faculty members have been approved for guiding research (Ph.D.) scholars in the domain of Electronics and Telecommunication

Engineering, Computer Engineering and Information Technology in the Mumbai University.

Like every year one -week Faculty Induction Program 2015 was successfully conducted in our college for the newly recruited faculty. All these figures recounts for an impressive record of our accomplishment.

The strenuous efforts provided by our management especially our Director, Bro. Melchior Tom, and our Deputy Director; Bro. Jose and staff members for developing SFIT into an Institute of excellence are commendable. We will continue our vigorous efforts in the direction of achieving excellence.

- DR. A. K. SEN



OUR MENTORS



**FROM L-R: < DR. THOMAS MATHEW (ACADEMIC ADVISOR)
BRO. TOM MELCHIOR (DIRECTOR), DR. A.K SEN (PRINCIPAL)
BRO. JOSE K.S (DEPUTY DIRECTOR)**



EDITORIAL : The STENTORIAN



THE PUBLICATIONS AND LITERARY COMMITTEE OF IRIS SFIT HAS REDEFINED ITSELF AS 'THE STENTORIAN'. DERIVED FROM THE GREEK MYTHOLOGY, STENTORIAN IS A PERSON WITH A LOUD AND POWERFUL VOICE ABLE ENOUGH TO GIVE A CLEAR MESSAGE AND EMPOWER KNOWLEDGE. RIDING THE NEW PHASE OF IRIS THIS YEAR 'THE STENTORIAN' IS DELIGHTED TO PUT FORWARD A COMPREHENSIVE RANGE OF EVENTS FOR GRAMMAR GEEKS, WORD-LOVERS AND DEBATE BUFFS.

THIS EDITION OF 'THE IRIS MAGAZINE' HAS BEEN CREATED WITH ALL OUR HEART. THE STENTORIAN IS PROUD TO PRESENT THIS YEAR'S E-MAGAZINE BASED UPON THE THEME 'AAMCHI MUMBAI'. AS PER TRADITION, WE BRING IN THE BASIC ELEMENTS OF A COLLEGE MAGAZINE. IT CONTAINS OUR PRECIOUS MEMORIES OF THIS YEAR IN THE FORM OF CLASS PHOTOS AND REPORTS OF THE ACADEMIC YEAR 2015-16 FROM OUR VARIOUS COMMITTEES. FOR THE VERY FIRST TIME WE HAVE INTRODUCED INTER COLLEGE DEBATE.



YOUTUBE HAS BECOME THE NEXT BIG PASS TIME AND KEEPING THIS IN MIND WE ARE THRILLED TO BRING YOU STREET INTERVIEWS TAKEN ACROSS MUMBAI. WITH THE AIM OF REINVIGORATING THE PAST WE ALSO HAVE INTRODUCED BLOGS THIS YEAR. WE ARE ALSO GOING TO CONDUCT A TERRIBLY TINY TALES WORKSHOP IN THE NEAR FUTURE.

HOWEVER, THIS YEAR, LIKE THE JALEBI'S SOLD ON THE STREETS OF MUMBAI, THERE ARE MANY TWISTS IN THIS EDITION. TO ADD A FEATHER TO THE CAP OUR E-MAGAZINE TEAM HAS USED VIDEOS AS WELL AS A SLIDESHOW AND HAS TRIED TO PRESENT THE MAGAZINE IN ALL OF ITS SPLENDOR AND GLORY. THIS YEAR HAS BEEN FRUITFUL, AS WE HAVE RE-INVENTED OUR WAYS OF CREATING THE MAGAZINE AND CONDUCTING VARIOUS ACTIVITIES. NONE OF THIS COULD BE POSSIBLE WITHOUT THE SUPPORT AND BLESSINGS OF OUR DIRECTOR, BR. TOM MELCHIOR, AND THE STENTORIAN STAFF. THIS MAGAZINE WILL TAKE OUR VIEWERS THROUGH AN AMAZING JOURNEY OF OUR BELOVED CITY MAKING IT SEEM AS IF YOU'RE WATCHING IT THROUGH THE IRIS OF AN SFITIAN'S EYE.

WE ALSO THANK RAISA DSOUZA FOR THE BACK COVER PAINTING.

-By THE EDITORIAL TEAM





ADAM NATHAN
(DIRECTOR)



JAINAM GANDHI
(DIRECTOR)

The Editorial Team



SWAPNIL SAMANT
(GRAPHIC DESIGNER/EXECUTIVE)

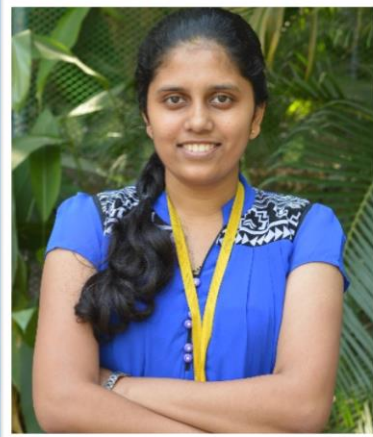

PREETIKA SHETTY
(GRAPHIC DESIGNER/EXECUTIVE)



STEFEN ROSARIO
(EDITOR / EXECUTIVE)

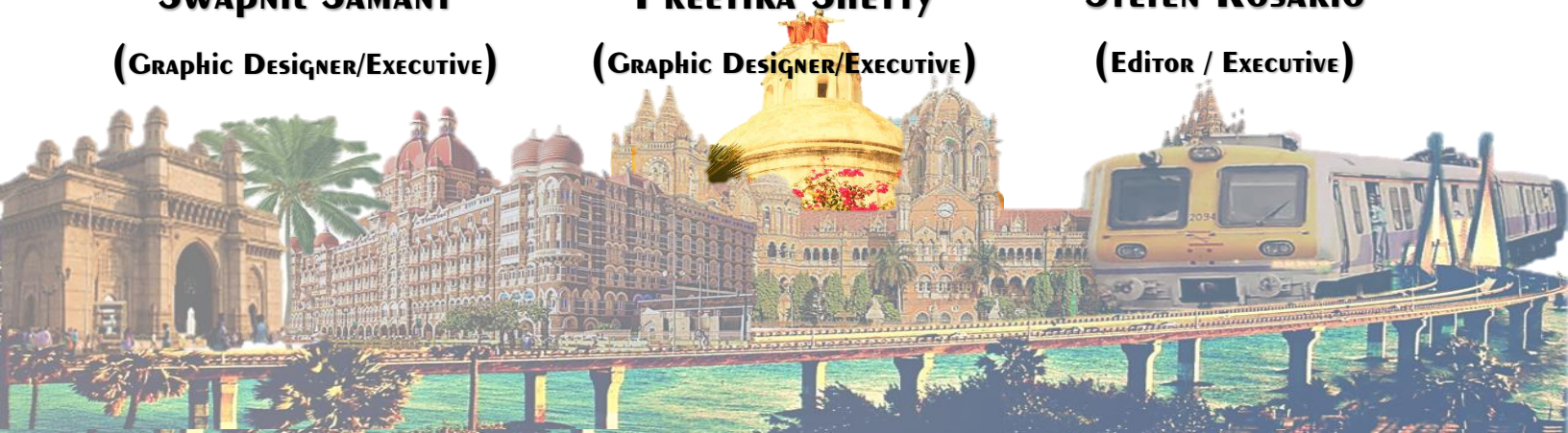



The Stentorian Staff



The Stentorian Students



Jedi's REPORT

AFTER A MEGA-SUCCESS OF IRIS'15, WE THE EVENT DIRECTORS OF IRIS TAKE PRIVILEGE TO BRING TO YOU IRIS'16 A THREE-DAY FESTIVAL SCHEDULED FROM THIRD TO FIFTH OF FEBRUARY. OUR THEME FOR THIS YEAR IS SOMETHING THAT STRIKES A FAMILIAR AND EMOTIONAL CHORD AND THAT IS AMCHI MUMBAI. AS DISPLAYED IN OUR LOGO, NUMEROUS FACETS OF MUMBAI MAKE IT AS VIBRANT, AS LIVELY AND SPIRITED AS IT IS. WE CHOSE THIS THEME AS WE WANTED TO CONCEPTUALISE ON THE IDEA THAT IS MORE 'LOCAL' IN WAYS THAT EACH AND EVERYONE COULD CONNECT TO IT, AS EACH ONE OF US FEELS SPECIAL ABOUT BEING A MUMBAIKAR. MUMBAI IS A RARE BIRD WITH MULTICOLOURED WINGS, AND THIS IS THE IDEAL WE WANT TO INCORPORATE WHEN IT COMES TO ORGANISING A FEST LIKE IRIS. BEING INCLUSIVE ENOUGH SO THERE IS SOMETHING FOR EVERYBODY. THE HEADS OF DIFFERENT DEPARTMENTS LIKE THE ADMINS, FINANCE, CREATIVES, PUBLICITY, SECURITY, SPORTS, GAMING, THE STENTORIAN, CULTURAL AND THEIR EXECUTIVES WORKING TOGETHER TO ENSURE THAT THIS IRIS IS A GRAND SUCCESS. WE AIM TO WORK AS SWIFTLY AS OUR MUMBAI LOCALS, AS ENTERTAINING AS BOLLYWOOD DO AND AS ENRICHING AN EXPERIENCE AS LIVING IN OUR CITY IS. BECAUSE OF THIS THEME, WE COULD EXECUTE NOVEL IDEAS LIKE STREET INTERVIEWS, WORKSHOP ON 'TIT', MAJOR EVENTS LIKE 'LASER TAG' AND 'CLASS OF THE YEAR' AND VARIOUS CONTINGENT EVENTS TO HAVE A BETTER FOOTFALL. WE EXTEND OUR GRATITUDE TO OUR ENTIRE IRIS 2016 COMMITTEE, OUR IRIS CO-ORDINATORS – SHAMSUDDIN KHAN SIR, GRINAL MA'AM, NAMRATA MA'AM AND SENIORS FOR THEIR SUPPORT AND GUIDANCE.

WE ALSO WISH TO THANK ALL OUR SPONSORS AND EVERYONE ASSOCIATED WITH IRIS'16.

L-R :- Achilles Rasquinha, KARRISHMA BHANDARI, MAYUR KULKARNI



STUDENT COUNCIL REPORT



THE ST. FRANCIS INSTITUTE OF TECHNOLOGY STUDENTS' COUNCIL IS WELL KNOWN FOR ORGANIZING THE COLLEGE'S FLAGSHIP EVENTS SUCH AS THE FRESHER'S PARTY/CONVOCATION, CELEBRATING INTERNATIONAL TEACHERS' DAY, LEADING INSTITUTION TECHNICAL FESTIVAL MOSAIC, ENCOURAGING CROSS CULTURAL GATHERING AND INTER-RELIGIOUS FESTIVALS FOR BOTH STUDENTS AND FACULTY. WE ALSO CATER TO THE NEEDS OF THE STUDENTS IN THE FIELDS OF EDUCATION, TECHNICAL AND CULTURAL COMPETITIONS, AND ISSUES PERTAINING TO WOMEN, SOCIETY AND THE ENVIRONMENT AS A WHOLE

THE STUDENTS' COUNCIL OF ST. FRANCIS INSTITUTE OF TECHNOLOGY IS KNOWN FOR BEING A DRIVING FORCE FOR STUDENTS WITHIN CAMPUS AND ALSO A GOVERNING BODY TO BUILD RELATIONS WITH COLLEGES BEYOND ITS BOUNDARIES. ESTABLISHED IN THE YEAR 1999, THE STUDENTS' COUNCIL REMAINS THE OLDEST STUDENTS' BODY OF THIS PRESTIGIOUS INSTITUTE. THE STUDENTS' COUNCIL, HOST CULTURAL AND TECHNICAL EVENTS FOR STUDENTS' ON CAMPUS AND BEYOND, PROVIDING ESSENTIAL SKILLS AND EXPERIENCE OF MANAGEMENT, SERVICE AND HOSPITALITY.





**To Publish Or Not to Publish is the
Question!**





By Bombay's Beach

How old WERE WE, FOURTEEN?

WHEN WE TOOK TO WALKING IN THE SANDS,

STROLLING DOWN THE BEACH,

SMILING AND TALKING, HAND IN HAND.

IT WAS HERE THAT I FIRST GOT TO KNOW,

YOU PREFERRED PANI PURI TO BHEL PURI,

VADA PAV OVER DABELI,

AND THE NAME "GIRGAUM CHOWPATTY" OVER "CHAUPATI"

AFTER ANOTHER TWO YEARS, WHEN YOU AND I WERE SIXTEEN,

WE STARTED OFF WITH COLLEGE, CLOSE TO THE SEA;

AFTERNOON SHOWS AT EROS WERE NOW THE NORM,

AS WERE EVENINGS SPENT AT THE PRINCE OF WALES MUSEUM.

THAT YEAR WE HAD OUR FIRST TRIP TO THE KALA GHODA FESTIVAL,

AND WE GOT OURSELVES CLICKED NEAR SHAINA NC'S GOLDEN THIMBLE,

AND ON THE WAY BACK YOU BOUGHT A RED BALLOON FROM A ROADSIDE KID,

FOLLOWED BY A COPY OF SHANTARAM FROM A VENDOR ON THE STREET.

AT EIGHTEEN AND NO OLDER,

WE VISITED THE GATEWAY OF INDIA,

AND JOKED ABOUT DINING AT THE TAJ,

OR MAYBE HAVING LUNCH AT THE TRIDENT.

BUT WE'D ALWAYS GO TO LEOPOLD'S INSTEAD,

HAVING SPENT THE AFTERNOON SHOPPING AT CAUSEWAY,

AND IT WAS THERE THAT WE HAD OUR VERY FIRST MUGS OF BEER,

ALONG WITH THE WORLD'S BEST PLATE OF PRAWN PULAO.

IN 2008, WHEN WE WERE 20 YEARS OLD,

EVERYTHING AT LEOPOLD'S FELT EXACTLY THE SAME,

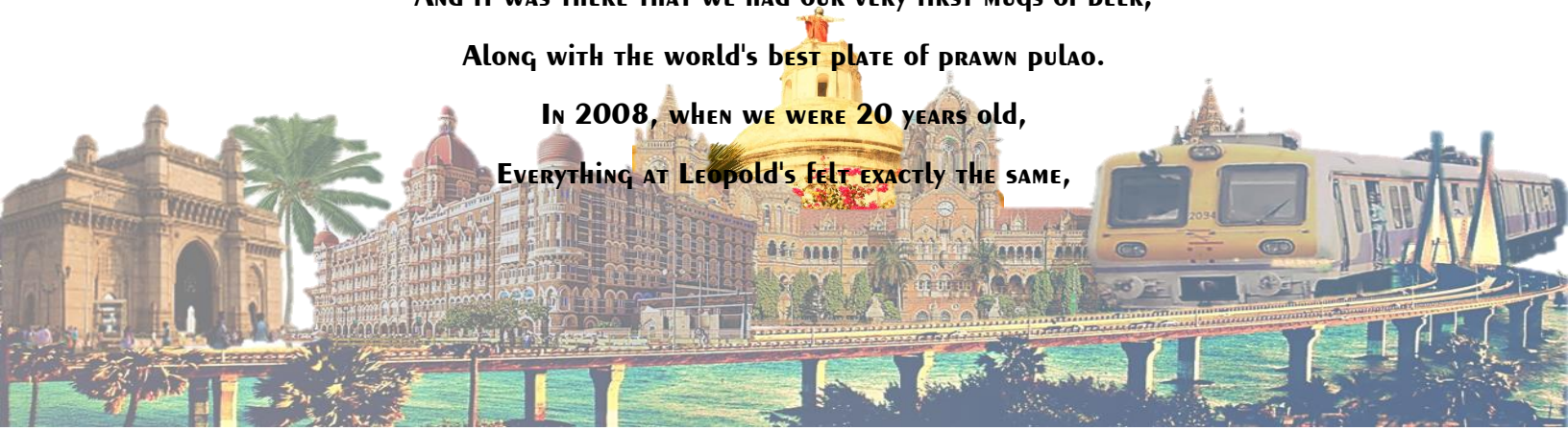

**AS WE SAT AT OUR TABLE WITH A GROUP OF OUR FRIENDS,
 AND ARGUED OVER WHICH STARTER TO ORDER NEXT;
 IN CAME TWO MEN WITH RIFLES IN THEIR ARMS,
 AND DRAINED THEMSELVES OF ALL THE BULLETS THEY HAD,
 I WATCHED YOU COLLAPSE TO THE FLOOR; AND SO I HELD YOUR HAND,
 LIKE WE DID AT GIRGAUM CHOWPATTY, BUT YOU DIDN'T HOLD MINE BACK.
 AND AS YOU LAY THERE I PRAYED TO EVERY GOD I COULD,
 ALLAH AT HAJI ALI,
 JESUS AT MOUNT MARY,
 GANPATI AT LALBAUG;
 I HELD MY BREATH, HOPING FOR A MIRACLE,
 A NOD OF YOUR HEAD OR A FLASH OF YOUR SMILE,
 MAYBE, JUST MAYBE YOU WOULD OPEN YOUR EYES,
 BUT YOU WERE GONE, AND THERE WAS NO GETTING YOU BACK.
 I STILL GO DOWN TO THE SEA YOU KNOW,
 WHENEVER THE PACE OF THE CITY GETS TOO MUCH TO BEAR,
 IN SILENCE I LET THE WAVES WASH MY FEET,
 WATCHING KIDS WHO NOW ARE WHAT WE USED TO BE,
 AND I BUY RED BALLOONS ON MY WAY BACK HOME,
 AFTER I'VE FINISHED WALKING THE ENTIRE SHORE,
 AND WISH YOU WERE HERE TO HOLD MY HAND,
 TO ONCE AGAIN, TAKE A STROLL WITH ME IN THE SANDS.**

- Aishwarya H. Balwani

BE EXTC



I GREW UP IN MUMBAI

YES I will be a proud Mumbaikar till my last breath. If not Mumbai where would you have been? Would your life be as exciting as living in Mumbai? Such questions do pop up in my mind. Mumbai is an infectious city because once you start living here I don't think living anywhere else will be that easy. A city that has hypnotized every soul that had taste of it. There is no home like Mumbai. People work here continuously and every deserted corner of the street will be crowded. More dreams are realized here than any other place in India. At every short distances you will explore new environment, new people. Time goes really fast here, you will have no time to regret about anything. Just go with the flow and accept the changes otherwise you will stand no where. It is a city that never sleeps, you will always feel safe and secure.

The best part here is the FOOD!!The street food, restaurants, stalls that we find here at every place is just mesmerizing! That hectic ride in local trains during peak hours is also worth an experience.

We all have been cherishing many memories with friends and family at places like Marine Drive, Juhu beach, Bandstand, Gateway of India, amusement parks like Essel World,so many malls, pubs and clubs out there to hangout almost every weekend. Our every joy and happiness lies in every part of this city.

People are connected over here. There is a special kind of attachment with this city which cannot be expressed in words. So last but not the least, I would like to add a quote: "Mumbai is a city but Bombay is an emotion".



-SALONI SOMAIYA
-SE IT B



India Wins Gold

ONE of my friends had uploaded a video (on Facebook), from the 2010 COMMON WEALTH GAMES FINALS, of the 4 X 400 M RELAY RACE. I SAW IT ONLY BECAUSE IT WAS ONE OF THE RAREST INSTANCES WHEN OUR "ATHLETES" HAD MADE IT TO THE FINALS OF AN INTERNATIONAL EVENT. MORE THAN THAT, IT WAS THE WOMEN'S TEAM WHO HAD MADE IT ON THE GRAND STAGE! WHILE WATCHING THE SPRINT, SOMETHING STRUCK ME AND I DECIDED TO WRITE ABOUT IT RIGHT THEN. BUT IT WAS NOT UNTIL BEFORE, I WAS IN THIS BEAUTIFUL YANKEE RESTAURANT WITH A BOWL OF MINISTRONE SOUP AND SOME CRISP BREAD, THAT THOUGHTS HIT HARD ON THE KEYBOARD.

IT WAS A TYPICAL RACE LIKE THE THOUSAND OTHERS THAT HAVE BEEN RUN EARLIER. BUT FOR ME THIS WAS DIFFERENT. I SAW THE SAME VIDEO AT LEAST HALF A DOZEN TIMES TO MAKE SURE THAT WHAT I WAS SEEING WAS FOR REAL... THIS IS A HUMBLE EFFORT TO RECREATE THE RACE ALBEIT WITH A DIFFERENT PERSPECTIVE ON IT. THE IDEA OF RELAY RACE IS TO HANDOVER A BATON TO THE NEXT RUNNER AWAITING AT REGULAR INTERVALS OF 100 M. THERE IS AN DESIGNATED TRANSITION SPACE IN WHICH THE RUNNERS MUST COMPLETE THE TRANSITION IN ORDER TO AVOID DISQUALIFICATION. THE TEAM THAT MAKES IT TO THE FINISH LINE FIRST, IS HERALDED AS THE WINNER. THE INDIAN TEAM WAS NO MORE THAN AN UNDERDOG OR MAY BE THE SPACE-FILLER IN THE HARSHTEST OF TERMS. THE FAVORITES WERE THE NIGERIANS AND THE ENGLISH. MANJEET KAUR, THE FIRST RUNNER IN THE INDIAN TEAM HAD A GOOD START AND SHE DID MANAGE A LEAD OVER HER ENGLISH COUNTERPART IN THE 40TH SECOND BUT WAS TIRING BY THE 45TH AND HAD TO SETTLE BEHIND THE NIGERIAN. AFTER THE TRANSITION SINI JOSE WAS IN HOT PURSUIT OF THE NIGERIAN, WHO BY THEN, AT THE 1 MINUTE 3 SECOND MARK, HAD TAKEN A HUGE LEAD. THE COMMENTATOR (COMMIE) WAS SCREAMING AT THE TOP OF HIS VOICE.

WITH THE NIGERIANS WAY AHEAD OF THE PACK, THE ENGLISH RUNNERS HAD CAUGHT UP WITH ASHWINI AKKUNJI, INDIA'S 3RD RUNNER. THE ENGLISH WOMAN WAS BREATHING DOWN ASHWINI'S NECK, BUT SHE WAS IN NO MOOD OF BOWING DOWN TO THE DESCENDANT OF THE IMPERIAL POWERS. PRECISELY AT THE 2:27.2 MARK ASHWINI, WITH HUGE STRIDES, TOOK THE LEAD AND THE STADIUM ERUPTED! THE COMMIE WENT BERSERK TOO. AT 2:36.65 HE YELLED, "INDIA IS GOING FOR GOLD!!!!"

THE LAST SPRINTER, MANDEEP KAUR, TOOK THE BATON FROM ASHWINI AND SHOT OFF HER TRANSITION ZONE. NIGERIANS WERE THERE TO WIN AND WOULDN'T HAVE GIVEN IT EASY. MANDEEP KAUR AND THE NIGERIAN WERE RUNNING NECK TO NECK STRUGGLING TO GET THAT FAINT LEAD. REST OF THE PACK WAS MILES BEHIND 'EM. FINALLY AT 2:51.4 MANDEEP HAD HAD ENOUGH AND KICKED HARD. FROM THERE ON THERE WAS NO LOOKING BACK AND THE GAP JUST WIDENED. THE CROWD WAS ECSTATIC.

THE WOMEN OF INDIA, BROUGHT HOME THE GOLD! AN EXCERPT FROM THE E-TABLOID, THE HINDU, READ "A.C. ASHWINI, A HURDLER, RAN THE RACE OF HER LIFE TO OVERTAKE NIGERIAN DAMMY ABOGUNLOKO AND GIVE INDIA THE LEAD MIDWAY THROUGH THE THIRD LEG. MANDEEP KAUR, THE ANCHOR, CONTINUED THE GOOD WORK AS THE HOST POCKETED ITS SECOND GOLD OF THESE GAMES AND ITS FIRST-EVER RELAY VICTORY IN THE GAMES HISTORY. MANJEET KAUR AND SINI JOSE RAN THE FIRST TWO LEGS."

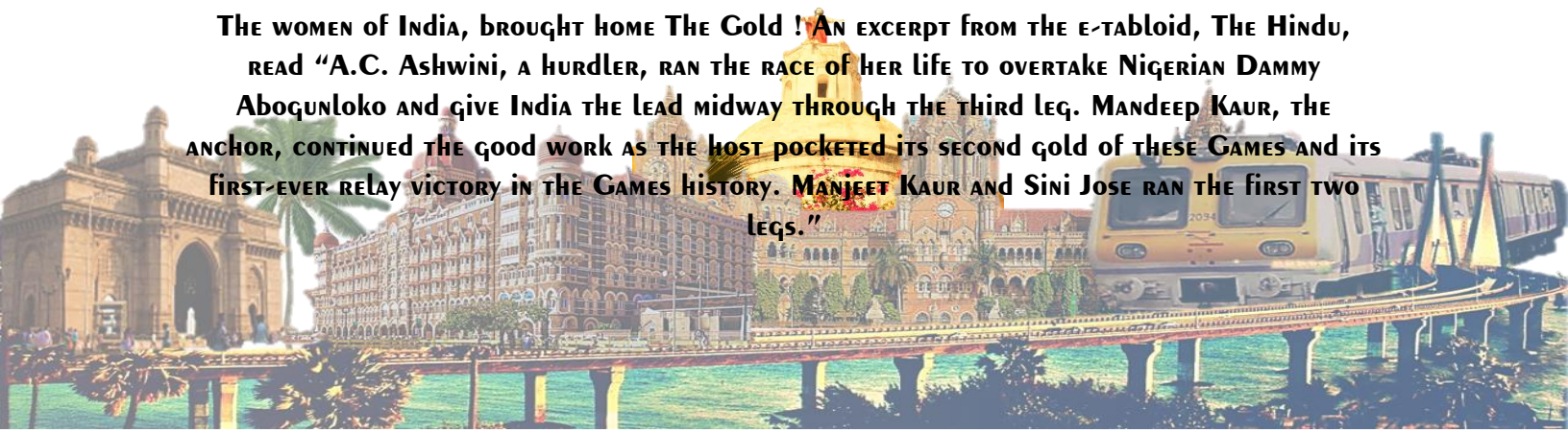

They had overcome all hurdles and grabbed the gold. Mind you, a lot of the gold medalists come from backgrounds, socio-politico-economical, that we wouldn't prefer given a choice. These young guns took that as a challenge surmounted and then thought about winning and so they did!

Well the blog wasn't intended to be a narrative of the event but without that, the crux wouldn't be reached. So while the fantastic-4 were sprinting towards victory, something struck me. That jolt actually inspired this blog. Let's look back at the race again. So, India had 4 runners. Each one was supposed to hand over the baton to the next one in the fastest and most efficient way possible. The commie yelled... "Here comes India..!!" and sometime later, "India is going for gold!" I drew a few analogies instantly.

- 1. The 4 runners represent 4 generations, loosely speaking, since independence.**
- 2. The baton represents various responsibilities and the track represents the world stage.**
- 3. Competitors are other nations in the race to glory and success.**
- 4. The sport of running represents a specific activity and could be anything ranging from forest conservation to innovation.**
- 5. Shoes and wear, would represent infrastructure**
- 6. The process of carrying the baton would be conducting day to day activities required as per point 4.**

Now having laid down these ground rules, I can merely say that – With the right kind of people who are focused and have a common goal, with proper training and right infrastructure we can provide transitions from one generation to other efficiently and create a better future. While other countries ponder over their drawbacks, India keeps forging ahead and gathering Gold by the heaps. So fellas I will just quote Swami Vivekanda to bolster the blogs message and bid adieu for now.

"Take up one idea. Make that one idea your life – think of it, dream of it, live on that idea. Let the brain, muscles, nerves, every part of your body, be full of that idea, and just leave every other idea alone. This is the way to success."

I think the video link is this: <https://www.youtube.com/watch?v=kezboiU3L-w>

**Vikram V. Shete, Ph.D.
Asstt. Professor St. Francis Institute of Technology,**



A Happy Realization

**EXHAUSTED AFTER SLOGGING, THROUGH A HECTIC SEMESTER,
 DECIDED TO TOUR THE COUNTRY, IN VACATIONS OF DECEMBER,
 A CHANGE FROM THE FAST PACE LIFE, WAS ANYWAY LONG DUE,
 SO LEAVING HOME I EMBARKED, UPON A JOURNEY NEW.
 HEADING TO THE SOUTH, SOUGHT TIRUPATI BALAJI'S BLESSING,
 CHERISHED THE CHILLY WEATHER, SIPPING TEA IN DARJEELING,
 THE TAJMAHAL IN AGRA, A MESMERIZING SIGHT,
 A DIP IN THE GANGES, BEFORE THE RETURN FLIGHT.
 THE SEARCH FOR PEACE OF MIND, DID NOT END OUTSTATION,
 DESPITE HAVING GONE A CIRCLE, TEN DAYS AROUND THE NATION,
 WITH REST AT HOME FINALLY, I HAD MY ENERGY RENEWED,
 REALIZING THE TRUTH IN HINDSIGHT, I CAN NOW CONCLUDE,
 AND ANSWER THE PUZZLED VISITOR IN THIS CITY, WHO ASKS WHY,
 IS THE BEST CITY IN INDIA TO LIVE, CALLED MUMBAI.**

-KOCHAR INDERKUMAR (ASST. PROFESSOR EXTC)



COMING OF THE NEW YEAR

**I find myself slipping AT TIMES,
 THE YEARS SEEM TO GO BY IN A SHIVER,
 BUT AS THE MIDNIGHT CHURCH BELLS CHIME,
 I KNOW THIS NEW YEAR WILL BE MY WINNER.
 THE RUSH OF THE COLD BREEZE,
 TANTALIZES ME WITH HOPE,
 ALL THE NEGATIVITY SHALL CEASE,
 AND THE OPPORTUNITIES WILL BE ROPED.
 I'LL WRITE AN EPIC NOW,
 OF ALL THE ADVENTURES I GO ON.
 THE OLD ME WAS A SKEPTIC,
 THE NEW ME, A WARRIOR BORN.
 BRAVE AND BOLD,
 SHALL TITLE THIS CHAPTER,
 STORIES WILL BE TOLD,
 THAT'LL ECHO FOR YEARS AFTER.
 MAYBE I'LL STUMBLE,
 SCRAPE MY KNEE ON THE GROUND,
 I COULD EVEN FUMBLE,
 BUT THE STRENGTH IN ME WILL BE FOUND.
 SO DON'T BE KIND NEW YEAR,
 DON'T HOLD BACK THE PUNCHES,
 I WANT TO LEARN HOW TO DODGE AND CLEAR,
 OR AT LEAST ROLL WITH THE CRUNCHES.
 THANK YOU '15, YOU WERE FILLED WITH WONDER,
 '16, LET'S EMBARK ON A JOURNEY,
 FILLED WITH PEACE,
 AND PROSPER.**

**-ARCHIE JOBARD
 SE Cmpn B**



The “Loq Kya Kahenge?” Syndrome

EVER BEEN THROUGH THESE ABOVE THREE MOST FRUSTRATING WORDS? I’M PRETTY SURE YOU MIGHT HAVE, NOT THE EXACT TERM, A GENERAL EXAMPLE WOULD BE YOU, GETTING COMPARED BY YOUR NEIGHBORS IN TERMS OF YOUR ACADEMICS, “Wo Mr.Sharma ke bete ko 95% aaye ,au tumhe sirf 94% , aisa KYU!!?” , when you discuss about this you will be like “BEEN THERE , DONE THAT”.

It’s NOT JUST PARENTS WE ARE TALKING ABOUT ALSO FRIEND, COLLEAGUES AND ALL SORTS OF PEOPLE. THIS SYNDROME HAS BEEN SUCCESSFUL IN CONQUERING OUR MINDS AND RULING EVER SINCE. BELIEVE OR NOT THIS IS ONE OF THE REASON WHERE A PERSON QUALITY OF BEING PRACTICAL HAS TURNED TO IMPRACTICAL.

A CASE STUDY TELLS THAT WHEN AN UNHEALTHY MARRIAGE IN INDIA REMAINS UNCHANGED FOR THE REST OF THE TIME DUE TO ASSUMPTION OF WHAT THE SOCIETY WILL THINK ABOUT THEM.

HENCE WE CAN SAY THAT THESE 3 WORDS ARE STRONG TO PREVENT SOCIETY FORM PROGRESSING. AND ALSO IT HAS KILLED MANY DREAMS (Saying ON A PERSONAL EXPERIENCE)

NOW THE SOLUTION IS VERY SIMPLE, firstly yourself stop doing THAT TO OTHERS, secondly HAVE A FIRM AND STRONG MIND SET, AND if you need ANY COUNCIL GUIDANCE find A PERSON WHO ISN’T POSSESSED BY THESE WORDS. AND DO WHAT MAKES YOU FEEL RIGHT AND MOTIVATIONAL, BUT IT SHOULD BE A GOOD THING OR ELSE FORGET IT.

And finally BE CONFIDENT AND LESS WORRIED ABOUT THE SOCIETY, AFTER ALL IT IS A QUESTION “Loq Kya Kahenge ?” , AND THE ANSWER TO IT IS “KUCH NAHI SOCHENGE ” CAUSE IT’S YOUR LIFE IS GETTING CHANGED WITHOUT AFFECTING THE SOCIETY’S LIFESTYLE , so do what’s best for you WITHOUT BOTHERING ABOUT THE SOCIETY

You cannot make everybody happy. Period.

"Your time is limited, so don't waste it living someone else's life." ~Steve Jobs

"No one can make you feel inferior without your own consent." ~Eleanor Roosevelt

-BRIAN COUTINHO



Mumbai without its street food

As I was scrolling down my 'Instagram' feed through all the food pics, I got a WhatsApp text from friends for our customary Sunday evening stroll. We set out towards our favorite hogging place. All along the way, we mainly discussed about the various eateries that have opened in every nook and corner of the town. After sinking my teeth into a sumptuous 'shawarma' and some juicy 'seekh kebabs' in IC, we headed to Borivali station. My friends left and I started my long walk back home. On my way, I noticed a small crowd around a corner. A more closer look led me to realize that it was actually our good old 'pani-puri wala' weaving his magic. As usual I couldn't hold back my temptations and gave in.

I had to wait a while for my turn as it was crowded. During this time I started reminiscing all my foodie escapades as I stood there lost in my thoughts watching the guy dish out those water-filled puris one after the other with much elan. I thought about the things I had earlier and now these pani-puris in a matter of an hour. All of it coming from diverse cuisines from different parts of the world. Shawarma being Lebanese, kebabs Mughlai and well 'pani-puri' coming from the northern parts of our country, all of it available in one small town in the suburbs of Mumbai.

Going further down this boulevard of thoughts I came to think about all the innumerable food options we get on the streets of this city that never sleeps. If there is one thing that can sum up the spirit and culture of Mumbai, is the culinary scene on the streets of the city. At any point of time, whether day or night, it is not possible for a person in search of food to go hungry. Even in the wee hours of the morning, you have the 'bread-jam' and tea vendors catering to the night crawlers of the city.

'Vada-pav' is a staple eaten for meals at all times of the day. From Chinese to Lebanese, Oriental to Tibetan, Bengali to Gujarati, South Indian to Punjabi, all kinds of cuisines can be found on the streets of Mumbai.

We are so used to satisfying our hunger pangs with these delicacies, it's hard to think about a life without them. But what if...what if...some day all these are not there. I know it's horrifying to imagine the deserted roads of the city without these street vendors. Yet, with the hap-hazard ordinances being passed everyday, the future can't be predicted. There shall be no 'cutting chai' to shake off our slumber in the mornings. No sandwich or dosa for breakfast. No hakka noodles or pizza for lunch. No 'bhel-puri' or 'franky rolls' for the evenings and no 'pav-bhaji' and 'kulfis' for dinner! Most badly affected people will be us students who rely so highly on these munchies to kill hunger, and well, for some people like me, kill the boredom! A lot of

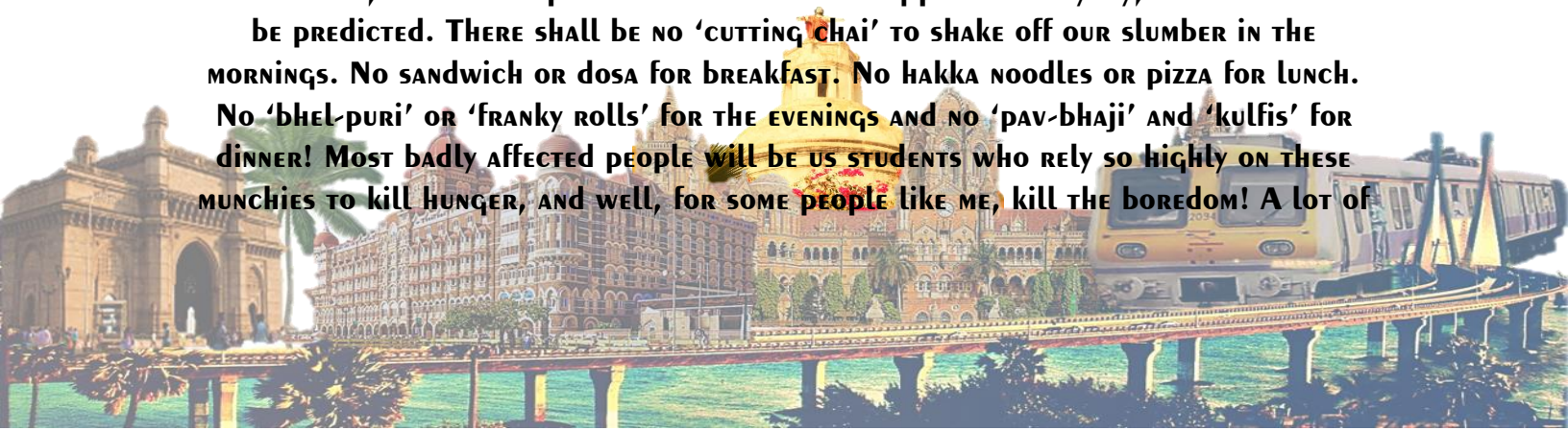

WORKING CLASS PEOPLE, TOO, ARE RELIANT ON THESE WORLDLY PLEASURES TO RELAX UNWIND AND ENJOY WHILST JUGGLING THEIR JOBS.

WE WILL HAVE TO COMPLETELY RELY ON EXPENSIVE RESTAURANTS AND FOOD CHAINS. ALTHOUGH THESE PLUSH OPTIONS SCORE MUCH HIGHER OVER THEIR STREET COUNTERPARTS IN WAYS OF HYGIENE, THEY WILL NEVER BE ABLE TO COMPETE WITH AWESOME FEELING OF HAVING 'CHAI' AND 'PAKORAS' ON A RAINY DAY BY THE ROADSIDE WITH YOUR HOMIES. ALSO, THESE ARE MUCH MORE AFFORDABLE OPTIONS FOR US STUDENTS WHEN WE ARE LOW ON MONETARY SUPPLIES(WHICH HAPPENS A LOT).



BHUSHAN SARAFDAR

BE ExTC



The Transition

A flashback scene of early 2000 engineering classroom – A class of around 60 students and the rarest gems in that class, yes, the girls! Hardly in a number of 10, shy and occupying a corner row or alternatively the first benches of the class.

Mingling with boys was occasional and the courtesy goes to the sharing of lecture notes! Now, in a class of 2016, the strength of girls raised to an average of 25 with the spirit no less than any boy in the classroom. Shyness is a distant thing and all of them are oozing great confidence. The Transition – Positive and welcomed!

More than a decade ago, the student teacher greetings were awesome. It may be little dramatic for this generation. Whenever any teacher and student used to cross each other, loud, enthusiastic and clear greetings were exchanged. There were instances of student's bowing down to teacher's feet due to sense of gratitude. Now certain students have added a little style quotient to it. 'Good Morning Sir/Madam' is replaced by a simple 'Hi/Hello'. Some are so expressive that they raise their eyebrows, a little side-smile and at times blink their both eyes to convey their greetings. (Hopefully blinking of one eye hasn't started yet ;) The Transition – Confusingly welcomed!

Sometimes what we see and judge is not always true. People have different shades and so do their lives which take at times a whole new turn. It was a happy moment to find that once an average looking, simple, introvert guy bags the best job and finds the best looking extrovert girl as a life partner. Two toppers of the class, total geeks, whom nobody could have imagined to look beyond studies and course work were actually love birds in disguise and are now hitched for life! Who ever knew that a fashion conscious and a handsome guy of the class would bear the scorching heat and chilling snow to become an avid travel enthusiast and a travel blogger? A guy who was popularly known as a singer-cum-guitarist and hardly interested in studies has now become a multimedia gaming design guru! The Transition – Surprising and pleasant!

But certain things would never change. Bunking the class, canteen gossips, last minute submissions, waking up at 8:45 AM and managing to successfully reach the class at 9 AM and many more. In fact, surprisingly, certain students still put their left/right hand forward seeking permission to enter the classroom! For many the photocopy guy

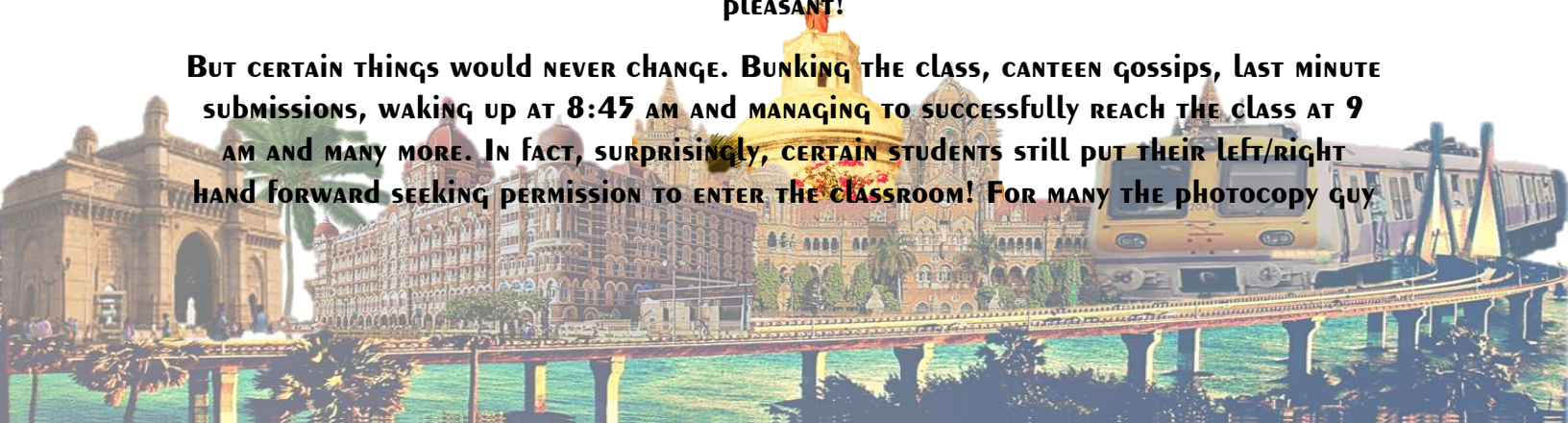

is still a best guide to collect notes and finding syllabus a night before the exams. On being asked about their ambitions, there are many who still gives the age old answer – ‘LET ME BECOME AN ENGINEER FIRST, THEN will decide what to do in life.’ The Transition – Nil!

NOT IN ENGINEERING, IN GENERAL, today's youngsters are chilled out, fearless and comparatively stress free. They can go into an insulator zone on being scolded by their parents or teachers. You may not find a handkerchief in their pockets but a smart phone is always there. Today's youth hasn't inherited the fear of its previous generation. They dare-to-think different and portray amazing confidence. It cannot be ignored that they are fully equipped with technology, consultancy and counseling information. At times there is an overload of information too. Thanks to the larger platform like Twitter and Facebook. If a friend is not available to listen to their outburst then one tweet is enough! They have a burning desire to prove something (absent in lectures though) and they are more vocal (except viva). They may forget to switch off the supply after removing the mobile from charger but then can wake up early and stay active to run a marathon. A new zeal and clarity is there in today's youth.

Still you will find certain critics quoting today's youth as greedy, lazy and guilt-free. According to them today's youth has a new epicenter – 'I'. But you cannot completely blame the youth. There are many others factors responsible for that and influencing them for these transitions. A youngster today prefers a stand-up comedian or a start-up owner as his role model than a political leader. Over and all, today's youth is more vibrant, clear, courageous and fortunate. The Transition – Openly welcomed! A word of advice – A little more humbleness and 'tolerance' won't do any harm! Oops! No more debate on intolerance please 😊

-NAMRATA MANKAD

(ASST.PROFESSOR EXTC)



WARNING ⚠ MUMBAI

START OF NEW MOMENT, NOT THEORY OF MOMENTS
EVERY MOMENT THAT BROUGHT DISGRACE TO OUR MUMBAI, HATING TO USE 'OUR'.
ALL BEHIND MONEY, THAT'S WHAT MUMBAI IS.
GO GREEN IS JUST THE MOTIVATION FOR DESTROYING GREEN, WITHOUT HURTING FEELINGS'
IMITATING WESTERNS' WITH THEIR FLAW, NEVER BOTHERED ABOUT WHAT WE HAVE
IT'S TRUE, HISTORY REPEATS ,AT LEAST LEARN, SAME POLITICAL TACTICS
NEVER LEARNT TO CLEAN MESS, JUST THE NEW WAYS TO CREATE MESS, LOVES THE MODERN
CULTURE, THE NEW RELIGION ,RUPTURING HUMANITY, IN THE NAME OF FASHION
ALL OUT OF MIND, RUNNING IN A RACE, ILLUSIONARY RACE OF SUCCESS, DESTROYING
INTERNAL MORALS, SUMMERTIME SADNESS, ALL OVER THE YEAR
PRETENDING IT TO BE THE BEST, SCREWING SELF, BECOMING STRONGER, PREDATORS OF FARMER'S
TIME IS YET TO COME, WAITING FOR IT, NEVER TAKE ACTION, JUST WATCHING LIQUID
CRYSTALS, RESPECT FOOD, STARVING IS THE CURSE
CAN'T BE ERADICATED, MANHUNT PREVAILING, THINK TWICE, END IS NEAR
POOR ARE NOT ILLITERATE, IT'S JUST THEIR COMPULSION
POWER IS WHAT THAT FORCES THEM, NEVER TAKE IT GRANTED, EVEN GOD'S HAVE FAILED,
POWER FAIL'S, PEOPLE ARE WORTHLESS, NEVER ACCEPT FAILURE
EGO AND PRIDE, PAVING WAY TO DEATH, TIMS AIN'T NO SAINT, TO COMMIT SUICIDE
(SAMADHI) ,FOR THE WELLBEING OF PEOPLE, WILL ALWAYS STAND AGAINST PREDATORS
MUMBAI IS INDIA, I DON'T SEE ANY BORDERS, USELESS GEOGRAPHY, TEACHING
DIFFERENTIATION, ABUSING CHILD'S MIND, STILL DEMANDING PEACE
THIS WORLD, THE HECK WORLD, TIRED OF ITS TACTICS
PRESENTING NEW TACTICS, TO ERADICATE ITS MATERIALISTIC POWER'S
BE WARNED.

Smit Lokhande
(BE EXTC -A)

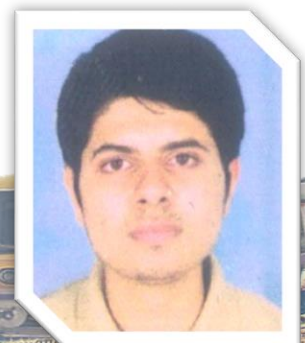

MANAGE STRESS- You don't HAVE TO ELIMINATE IT

IN TODAY'S MODERN ERA STRESS HAS BECOME VERY COMMON AMONG EVERYONE ESPECIALLY COLLEGE STUDENTS. THE UNFORGIVING PACE AND COMPLEXITY OF MODERN LIFE HAS GREATLY CHALLENGED OUR ABILITY TO LIVE HEALTHILY AND FULLY IN THE PRESENT MOMENT. SO WHAT IS STRESS? IN WHAT SCENARIOS DO WE USE THE WORD STRESS? MANY OF US HAVE DIFFERENT INTERPRETATIONS ABOUT THE WORD STRESS.

WE GENERALLY USE THE WORD "STRESS" WHEN WE FEEL THAT EVERYTHING SEEMS TO HAVE BECOME TOO MUCH, FOR EXAMPLE IF WE HAVE A LOT OF WORKLOAD OR WONDER WHETHER WE REALLY CAN COPE WITH THE PRESSURES PLACED UPON US. STRESS IS INEVITABLE AND IT AFFECTS ALMOST EVERYONE. SPEAKING OF COLLEGE STUDENTS, STRESS AFFECTS THEM IN MANY DRASTIC WAYS.

COLLEGE STUDENTS HAVE A LOT TO THINK AND DO AT THE SAME TIME FOR EXAMPLE DOING WELL IN EXAMS, COMPLETING ASSIGNMENTS ON TIME, DEALING WITH PEER PRESSURE, ETC. SOMETIMES STUDENTS HAVE TO WORK WITH MANY NEW PEOPLE, INVOLVE INTO GROUP DISCUSSIONS, MAKE DECISIONS ON THEIR OWN AT A HIGHER LEVEL WHICH ALSO CAUSES NERVOUSNESS AND SOMETIMES STRESS. STUDENTS ALSO WORRY ABOUT MANAGING TIME IN ORDER TO COMPLETE EVERY TASK GIVEN TO THEM. SLEEP DEPRIVATION CAN CAUSE MANY PHYSICAL AND MENTAL PROBLEMS AND CAN INCREASE STRESS. WELL, IT'S ABSOLUTELY NATURAL FOR EVERY HUMAN BEING TO GET STRESSED OR WORRIED IN SUCH SITUATIONS, PROVIDED THAT IT DOES NOT AFFECT THEM IN THE LONG RUN. AT TIMES STRESS MAY BE HELPFUL. A FIRE ALARM IS INTENDED TO CAUSE THE STRESS THAT ALERTS YOU TO AVOID DANGER. THE STRESS CREATED BY A DEADLINE TO FINISH A PAPER CAN MOTIVATE YOU TO FINISH THE ASSIGNMENT ON TIME.

BUT WHEN EXPERIENCED IN EXCESS STRESS CAUSES VARIOUS EFFECTS ON US. EFFECTS SUCH AS HIGH BLOOD PRESSURE, DEPRESSION, WEAK MUSCLES AND IMMUNE SYSTEM, RAPID BREATHING ETC ARE SEEN. STRESS CAN HARM OUR EMOTIONAL AND PHYSICAL HEALTH, AND LIMIT OUR ABILITY TO FUNCTION AT HOME, IN SCHOOL, AND WITHIN OUR RELATIONSHIPS.

WHILE STRESS HAS MANY ILL EFFECTS THERE ARE VARIOUS STRESS MANAGING STRATEGIES. FIRSTLY A HEALTHY MIND AND BODY IS WHAT IS REQUIRED IN THE FIRST PLACE. THIS CAN BE ATTAINED BY HAVING A BALANCED DIET WITH AT LEAST 30 MINUTES OF ANY PHYSICAL EXERCISE LIKE CYCLING, RUNNING OR ANY OF OUR FAVOURITE SPORT. WE SHOULD ALSO REDUCE OUR CAFFEINE INTAKE AS IT DEHYDRATES THE BODY. OTHER METHODS OF REDUCING STRESS AND ENHANCING OUR COLLEGE EXPERIENCE INCLUDE KEEPING OUR MIND ORGANIZED, MAINTAINING CONTACT WITH OUR FAMILY, FRIENDS, PROFESSORS WHO MAY

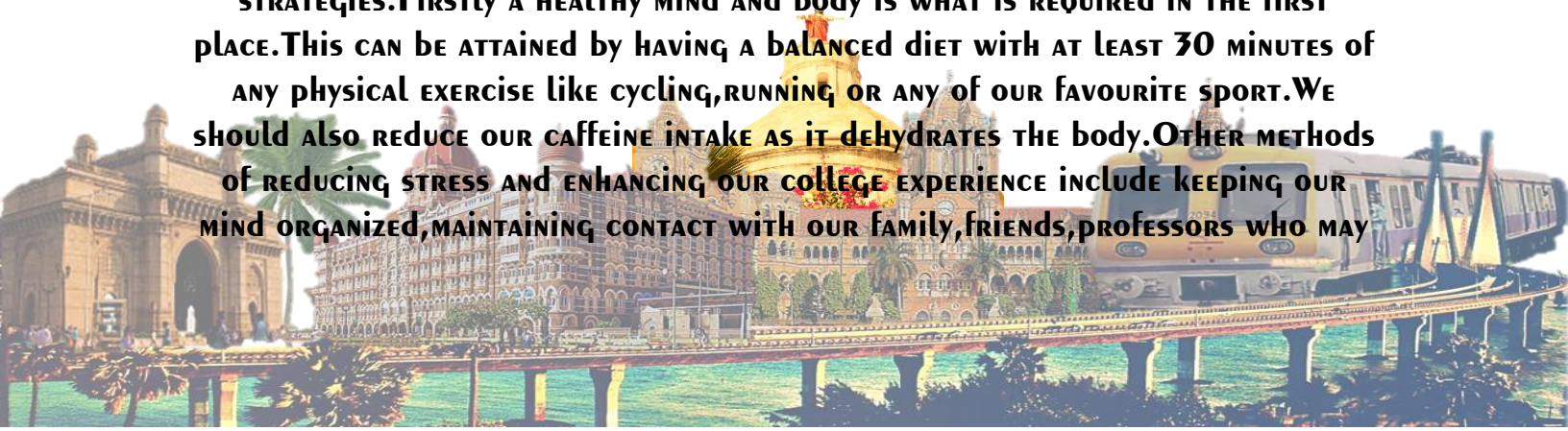

also guide us at any time. Setting realistic goals for ourselves can also help us improve our mood and complete any task on time without having to worry about the same. Adequate sleep fuels our mind, as well as your body. Feeling tired will increase our stress because it may cause us to think irrationally. When our minds continuously feed us messages about what we “should” achieve, “ought” to be, or “mustn't” do, we are setting ourselves up to fall short of goals that may be unrealistic, and to experience stress along the way. Hence we need to be optimistic and try to avoid such thoughts. When facing challenges we must look at them as opportunities for our personal growth.

At times we all feel stressed because of various reasons but ultimately what matters is how we are able to manage stress. Stress cannot be eliminated completely but its effects can be avoided by several control measures. Hence we all must try to manage stress in every possible way we can, if we are not able to completely eliminate it.



AARON LEMOS

FE CMPN -A



THE LOVELY TWO

(DEDICATED TO MOM AND DAD WITH LOTS OF LOVE)

**LIFE IS LIKE SUNSHINE BEAUTIFUL AND NICE,
YOUR PRESENCE ALWAYS MADE IT BRIGHT;
LITS MY HEART YOUR ETERNAL LOVE,
BECAUSE YOU ARE MY LOVELY TWO.**

**THE GOOD YOU TAUGHT ME ALL THIS WHILE,
TO BE HUMBLE , SWEET AND POLITE;
LIKE A BEAUTY YOU SET ME UPRIGHT ,
YOU LOVELY TWO ARE MY KNIGHTS .**

**IN DESPAIR AND GRIEF YOU SUPPORTED ME ,
WHEN FAILURE AND DARKNESS CRUSHED ME ;
WITH SHAKEN FAITH , MY HOPE WAS GONE & DREAMS WERE LOST ,
BUT ON ME YOU LOVELY TWO NEVER GAVE UP .**

**FOR THIS AMAZING LIFE I THANK YOU BOTH ,
FOR THE TIMES I HURTED YOU I SAY I AM SORRY ;
WITHOUT YOU MY WORLD IS MERE DUST ,
IN ME YOU LOVELY TWO ALWAYS KEEP YOUR TRUST .**



**MOM YOU ARE MY SUPERSTAR , Dad YOU ARE MY HERO ,
YOU ARE THE BEST'EST LOVELY TWO ;
WITH THESE FEW LINES I WRAP MY WORDS ,
I LOVE YOU VERY MUCH YOU MY LOVELY TWO .**

**--SALOMIE PEREIRA
(SE CMPN B)**



Pull me out... - The dying hero.

**ON A DOWNWARD SPIRAL TO THE DARK,
 GOES A STAR OF GREAT SPARK.
 Sighs, pleads and shouts,
 Pull me out, pull me out!**

**HE ONCE HAD THE GLORY OF A WINNER,
 NOW WHAT REMAINS IS A SILVER LINE THINNER.
 HE SEARCHES YOU WITH AN OUNCE OF HOPE;
 pull me out, pull me out.**

**HE WAS AN AMBITIOUS CHILD,
 BUT GREW UP TO MAKE HIS AMBITIONS MILD.
 REQUESTS HIS FEEBLE VOICE,
 pull me out, pull me out!**

**HE HAD MORALS THAT MADE HIM PROUD,
 HE CHANGED, TO BECOME ONE FROM THE CROWD.
 WAITS FOR YOUR MERCIFUL HAND;
 pull me out, pull me out!**

**A DREAMER TO THE DRIVE THE WORLD INSANE,
 NOW SETTLED FOR THINGS SO MUNDANE.
 Calls you for help,
 pull me out, pull me out!**

**AN ACHIEVER WHO TOOK LONELY STRIDES,
 NOW RUNS IN A HERD WITH AN ENDLESS RIDE.
 PLEADS THE MISFIT TRAVELER,
 pull me out, pull me out!**

**THE SELF IGNITED WHO ONCE SPREAD LIGHT,
 NOW ENTANGLED BY DARK, PUTTING UP A FIGHT.
 ONE HAND TO SET EVERYTHING RIGHT;
 pull me out, pull me out!**

-CHINTAN MISTRY

(BE CMPN)



MOVE AWAY FROM THE REAL SCENE.

**MARCH TOWARDS A WISFUL DREAM.
WALK BENEATH THE CARPET OF THE SKY,
NEAR THE OCEAN AND THE COCONUT TREE,
NO LONGER DO YOU WANT TO SCREAM.
TO DELIGHT YOURSELF WITH DREAM.**

**MOVE AWAY FROM THE REAL SCENE.
MARCH TOWARDS A WISFUL DREAM.
TO SMELL THE AIR THAT'S SALTY-SWEET.
TO HEAR THE BIRD'S TWEETER TWEET.
TO LET SOFT SAND CARESS YOUR FEET.
TO FEEL THE WINDY BREEZE.
TO HAVE THE NATURE'S TREAT.**

**MOVE AWAY FROM THE REAL SCENE.
MARCH TOWARDS A WISFUL DREAM.
WALK OVER MILES.
JUST TO SEE ,
THE PLAYFUL WAVES HIT THE SHORE.
AND THE VOICE OF THE TIDE.
THAT CLEANS WITH NOISE,
AND IMPOSES A RHYTHM UPON EVERYTHING,
THAT IS BEWILDERED AND BORED.**

**MOVE AWAY FROM THE REAL SCENE.
MARCH TOWARDS A WISFUL DREAM.
LISTEN TO THE SONG IT SINGS,
TO MAKE LOVE AND PEACE WITHIN.
LEAVE ALL THE LITTLE THINGS.
AND SMOOTHEN OVER THE DENTS AND GRIEVES.
MAKE YOUR DREAM REAL BIG.**



**MOVE AWAY FROM THE REAL SCENE.
MARCH TOWARDS A WISFUL DREAM.
AND YOU WILL SEE,
THAT'S WHAT LIVING IS ALL ABOUT .
IN THE NATURE'S CRADLE HEREBABOUT.
THIS DREAMY LIFE ,HAS NO END.
THERE IS ALWAYS MORE, BEHIND THE BEND.**

**OH MY FRIEND,
LIVE YOUR LIFE,
LIKE YOUR DREAM.
NEVER LET IT DOWN.
ALWAYS FILL IT UP WITH GLEE.**

-Anjali Pai (TE INFT A)



A life of a girl is full of challenges. She needs to fight and withstand all the challenges in this world. The unjust attitude of the world tests her patience, strength at every step. Yet she emerges out strong and defeats all the problems. So kudos to this spirit. I dedicate my this poem to womanhood!!

FREEDOM

I WANT TO WALK MILES ALONE FREELY,

BUT I CAN'T! I AM SCARED REALLY....

I WANT TO FLY HIGH LIKE A BIRD,

BUT I AM PULLED BACK AND RESTRICTED BY THIS WORLD....

WHY SUCH INJUSTICE TO ME? ONLY BECAUSE I AM A GIRL??

ANSWER ME! OH YOU PEOPLE OF THIS MEAN, UNJUST WORLD...

I WANT TO BREATHE FREE,

NO BONDAGE! ONLY MY DREAMS AND ME...

WHEN WOULD THAT DAY COME, WHEN I WOULD STOP CHECKING TIME!

AND WOULD ENJOY EVERY MOMENT OF LIFE WITHOUT ANY FEAR OF CRIME...

IT'S THE TIME FOR US TO CHANGE, IT'S TIME FOR OUR TRUE WISDOM,

YES PEOPLE! IT'S TIME FOR EVERY GIRL TO LIVE HER **FREEDOM!!**

- DURVAKSHI NARE

(SE EXTC B).



BHARAT

**BHARAT, ONCE A LAND OF GOLD!
WHERE TREASURIES AND INTELLECT OVERFLOWED.**

**PROUD OF ITS BEAUTY AND POTENT,
BUT KNEW TO BE MODEST, AND YET BOLD!**

**PERSIANS TOOK REFUGE IN HER GENEROSITY,
BUT MUĞHALS TOOK IT AS HER STUPIDITY.**

**SHE LET HERSELF GET EXPLOITED,
TO GRADUALLY REALIZE THEIR ATROCITY!**

**FIGHTING WITH A BARBARIAN,
LET HER SELF-ESTEEM DRAIN.**

**SHE ACCEPTED HER DEFEAT,
TO TEACH THEM MORALS IN VAIN!**

**THE CLASSY ENGLISH MAN STRETCHED HIS HAND,
AND SHE GRASPED IT HARD WITH ALL HER LAND.**

**PLEASED TO KNOW HE HAD COME TO HER AID,
BUT SOON REALIZED, HE JUST WANTED TO TRADE.**

**IT WAS HER MOMENT OF WEAKNESS,
THAT PORTRAYED HER AS WORTHLESS.**

**WITH ONE HAND HE HELPED,
AND THE OTHER, HE HUMILIATED.**

**DID SHE REALLY NEED HIS FAVOURS?
OR DID SHE WANT HER RESPECT?**



**SHE REJECTED HIM IN EVERY WAY,
AND CHASED HIM OUT ON ONE BRIGHT DAY.**

**THE ENGLISH LEFT WITH NO OTHER OPTION,
AND SHE CELEBRATED HER FREEDOM.**

**WITH POVERTY, ILLITERACY AND CORRUPTION,
OVER FAMINES AND HER DISINTEGRATION.**

**THEN SHE LOOKED AT THE CITIES AND THE BRIDGES,
THE SCHOOLS, RAILWAYS, AND THE POWER HOUSES.**

**THE ENGLISH DID NOT COME JUST TO ROB HER,
BUT HAD NOW GONE, LOATHED IN GRUDGES.**

**COULD SHE SIT TO SULK AND REGRET?
OR RAISE HERSELF HIGHER WITH A GRIT?
SHE HAD TO GROW THAN EVER BEFORE,
AND SHOW THE WORLD, SHE COULD OFFER MORE!**

**EVEN AFTER SEVENTY YEARS,
THE ENGLISH CALLS HER "THE LAND OF SAVAGES".
HOW LONG MORE WILL SHE TAKE TO PROVE,
"BHARAT, WAS AND IS A LAND OF GOLD" ?**



Sridari Iyer
ASST. PROF, CMPN



Taking the time

Taking The Time

ANXIOUS AND edgy, NOT SURE WHERE TO GO
AN UNKNOWN place filled with STRANGERS ON A ROW
THE TIME WE STARTED, EVERYTHING WAS LOW
SOON IT BECAME A PART OF OUR LIVES, A SECOND HOME TO STAY
Work HARD, grow AND play.
STRANGERS TURNED INTO FRIENDS WE COULD NEVER SLAY
All FACES KNOWN AND THE PAPERS TORN
TOGETHER WE FAILED AND EVERY LITTLE PAIN WAS BORNE
SUCCEEDED IN COMING OUT OF THE THICK AND THORN
GRADUALLY, MASTERING THE ART.
CLOSER TO THE END, FAR AWAY FROM THE START
YEAR AFTER YEAR, HITHER I LEFT A PART
NIGHT'S THAT WERE USUALLY LATE
Trying TO COME OUT AS A CLEAN SLATE
Slowly AND STEADILY, WE REACHED THE GATE
TAKING THE RIGHT TIME, FOUR YEARS AND WE GRADUATE.



Rushvi Jain BE IT A



Mumbai My City

JEWEL OF THE INDIAN REPUBLIC WHERE WEALTH FLOWS LIKE A RIVER

YOU MAKE THE JEALOUS HEARTS OF OUR ENEMIES SHIVER

FROM TIME AND TIME OUR ENEMIES TRIED TO BREAK YOUR SPIRIT

WHAT NEW TO SAY TO ESTABLISH YOUR MERIT

IT WAS ONE SUCH DAY YOU EXPERIENCED SEVEN ELEVEN

IT FELT LIKE THE DEAD WERE CRIED FOR EVEN IN HEAVEN

THE TRAINS THAT WERE YOUR LIFELINE

TURNT INTO GRAVES WITH NO HELP FROM DIVINE

BUT DON'T YOU STAND EVERY TIME YOU FELL

FOR YOU CONTINUE TO STRUGGLE EVEN IF LIFE BECOMES A HELL

CAME TWENTY SIX-ELEVEN AND THE TAJ BURNED

HAD THE ENTIRE COUNTRY FOR REVENGE YEARNED?

YOU CAME UP LIKE HOPE COME TRUE

IN THIS WORLD THERE ARE CITY LIKE YOU FEW

HAD YOU NOT FACED SUCH A MIGHTY FLOOD?

THAT IT FILLED YOUR ROADS WITH CORPSES OF BLOOD

FOUGHT AGAINST THE FLOOD AND DID YOU NOT RISE

NEVER WOULD HAVE ONE SURVIVED A DISASTER OF THIS SIZE

O DEAR CITY IN YOUR BOSOM BLESSED ARE WE

HAVE WE SEEN A WORLD IN YOU WHICH ONE MAY NEVER SEE



-Mohit shetty(TE CMPN A)





" हम भविष्य देश के "

आधुनिकता और आधुनिकीकरण,
इस अंधी दौड़ का कर अनुसरण,
मझधार में अटक गए है हम ।

टीवी कम्प्यूटर और मोबाइल की है यह दुनिया,
सुविधा है या दुविधा ,
इस उलझन में उलझ गए हैं हम ।

स्क्रीन के उजालो के पीछे के अँधेरे,
अभिमन्यू को चक्रव्यूह में घेरे,
उज्ज्वल भविष्य पर लगे है प्रश्नचिन्ह बहुतेरे ।

अहिष्णुता छोड़े हम खुद के साथ,
अपने आप से भी करे संवाद,
रिमोट है हमारे ही हाथ ।

" हम भविष्य देश के " कभी न भूले हम,
आओ आज एक सच्ची प्रतिज्ञा लेले हम ।



उमंग भट्ट

SE EXTC



मुंबईमेरी जान

समुद्र की लहरों से टकराता,
 अजनबियों को हाथ पकड़ अपनाता,
 बेरोजगारों का रोजगार,
 बेसहारों का सहारा,
 सपनों के पंख लगाकर,
 मंज़िलों पर उड़ाता.....ऐसी ये मेरी मुंबई

बेकाबू और बेबस,
 बेचैन और बेलगाम,
 बेपरवाह और बेताब,
 बिंदास और बेमिसाल.....ऐसा ये मेरा शहर.

वडापाव की खूशबू से मेहकता,
 गुंडागर्दी की आहट से थरथराता,
 यहां बॉलीवुड की चमक भी है,
 यहां रुपयों की खनक भी है,
 यहां अमीरी-गरीबी साथ पनपती है.....ऐसा ये मेरा शहर

.....

मुश्किलों से लोग डरते नहीं जहाँ,
 बहादुरी की आला मिशाल है, मुंबई,



हर धर्म, हर तहजीब को अपना बनाता,
हर दर्द की दवा बन जाता,
हर हादसा हिम्मत से हजम कर जाता.....ऐसा ये मेरा शहर
बड़ी तेज़ रफ़्तार से चलता,
रातों को कभी नहीं सोता,
मुरदों में भी जो जान डालता,
हर सपनो के मोती पिरोता,
मेरी जान...मेरा दिल...मेरा जूनून है...
मेरा ये शहर मुंबई....मेरी जान मुंबई !!!



Aarti P Dave

TE CMPN A



दुनिया से बेहतर

ऊब गया था जब मन मेरा, वर्ष भर श्रम कर
 सोचा दिसंबर के अवकाश में, चलें देश भ्रमण पर
 आखिर इस भागदौड़ भरी, जिन्दगी से हटकर
 निकल पड़े कुछ दिनों के लिए, घरवालों को छोड़कर

 प्रथम किये जाकर दक्षिण, तिरुपति बालाजी के दर्शन
 दार्जिलिंग के मौसम का लुत्फ उठा, देखे चाय के चमन
 निगाहों में भरा आश्चर्य, देख उत्तर में ताजमहल
 पावन गंगा में नहा आखिर की, वापसी की पहल

 जिस सुकून को खोजने चले थे, अपनी ही गलियाँ तजकर,
 मिल न सका हमें वह, लगाकर वतन का चक्कर,
 निष्कर्ष पर शाम को पहुंचा, जब सुबह का भूला कोचर,
 यही समझा की अपनी मुंबई है, सारी दुनिया से बेहतर

-कोचर इन्दरकुमार



काश फिर से मैं बच्चा बन जाऊं

माँ की गोदी में फिर से सर रख पाऊँ ;

दुनिया की सारी खुशियाँ उस चोली में पाऊँ

काश फिर से मैं बच्चा बन जाऊँ।

फिर से मैं तो शरारत कर पाऊँ,

फिर से माँ की डांट सून पाऊँ ,

फिर से माँ मुझे दुलार करे ,

काश फिर से मैं बच्चा बन जाऊँ।

काश फिर से वो खिलौने माँग पाऊँ,

माँ के देने पर उसके गले लग पाऊँ

फिर से माँ के हाथों को पकड़ कर चल पाऊँ

काश फिर से मैं बच्चा बन जाऊँ

भगवन से दुनिया का खज़ाना न माँगू

माँगू तो मैं बस प्यारी माँ माँगू,

माँगू तो भगवन से यह माँगू

काश फिर से मैं बच्चा बन जाऊँ

विजेन्द्र कुमार प्रजापति



चाँद !

चाँद पूरा हो या अधूरा ,
देख कर साँसे थम जाती हैं।
हाथ बढ़ाते हैं उसे छूने को,
काश हम पहुँच पाते !

किसी की आँखों का नूर हैं ,
और किसी शायर की ग़ज़ल।
हर इंसान की चाहत हैं,
काश उसे हासिल कर पाते !

कभी तन्हा दिल का साथी हैं,
तो कभी भटकते राही की मंज़िल।
हर दीवाने का सपना हैं,
काश उसे अपना पाते !

पर चाँद हैं एक बेजान पत्थर,
जिसकी हर दिशा में हैं सिर्फ अँधेरा।
बस पृथ्वी के चक्कर काटता रहता हैं,
इसे आकर्षण कहें, या उसकी मजबूरी ?



Sridari Iyer

Asst.Professor CMPN Dept



परदेस

पंछी पिंजरा छोड़, उड़ चला
छोड़कर अपना प्यारा वतन
निकल पडा नयी राह की ओर
भुलाकर अपनी मिट्टी की सेंध
चला गया तू परदेस !!

परदेस की हवाओं में यू खो गया
भुलाया अपना दोस्त, परिवार
जो सुख - दुःख में तेरे साथ थे
उन्हें मझदार में अकेला छोड़कर
चला गया तू परदेस !!

जिनके साथ तूने बचपन है बिताया
उन्ही दोस्तोंको जवानी में अकेला छोड़ दिया
जिस आँगन में तू खेला - कूदा करता
वह आँगन आज विरान कर
चला गया तू परदेस !!

जिन गलियों में हम घूमा करते थे
उन गलियों को है तुम्हारी राह
जहाँ हर पल हँसी गूँजती रहती



आज वहाँ सन्नाटा कर
चला गया तू परदेस !!

आज भी तुम्हारी माँ गली के चौराहे
नजर बिछाए तखति है तुम्हारी राह
बुढ़े पिताजी लकड़ी की काठी को बेटा समझ
बुढ़ापे का सारा बोझ उसपे ढोते है
राखीवाले दिन तुम्हारी बहन
हाथ में राखी थाम, ढूँढती है तुम्हारी कलाई
इन सब अपनों को दुखियारा कर
चला गया तू परदेस !!



Raheem Sayyed

Library Attendant





कवी मंगेश पाडगावकर - एक शब्दांजली

सरत्या वर्षाचा शेवट मराठी साहित्यातील एक ज्येष्ठ कवी श्री मंगेश पाडगावकर यांच्या निधनाने झाला. संपूर्ण साहित्य जग आणि वाचकवर्ग त्यांच्या निधनाने हळहळले. त्यांच्या स्मृतीस अभिवादन करून या ज्येष्ठ कवीला आदरांजली वाहण्यासाठी मी हा लेख लिहित आहे. मराठी साहित्यात द्यानेश्वरांपासून सौमित्र पर्यंत अनेक कवी झाले. सगळ्यांचेच कर्तुत्व मोठे होते. परंतु पाडगावकरांना कवी म्हणून मिळालेली लोकमान्यता फारच कमी कवींच्या वाट्याला आली असेल. त्यांच्या तोंडून त्यांची स्वतःची कविता ऐकणे हा एक आनंददायी अनुभव होता. विंदा करंदीकर आणि बापट यांच्यासह त्यांनी ठिकठिकाणी काव्यवाचनाचे कार्यक्रम सादर केले आणि पुस्तकातून असणारी कविता लोकांच्या हृदयापर्यंत जाऊन पोहोचली. प्रेम हा विषय त्यांच्या कवितेच्या केंद्रस्थानी होता. प्रेमाच्या छटा सांगणारी अत्यंत तरल अशी त्यांची कविता होती. धारानृत्य, जिप्सी या कवितासंग्रहातून हि कविता भेटते. याउलट 'सलाम' या कवितासंग्रहात राजकीय भाष्य करताना त्यांची भाषा अत्यंत टोकदार, मार्मिक आणि उपहास यांनी ठासून भरलेली होती. बालकविता, वात्रटिका, प्रेमकविता, बोलगाणी असे काव्यप्रकार त्यांनी अत्यंत कुशलतेने हाताळले. मीरा व कबीर यांच्या कवितांचे अनुवाद केले. हा अनुवाद सुद्धा मुळ कविते इतकाच शुद्ध अध्यात्मिक अनुभव देणारा होता.

श्रावणात घन नीळा बरसला, दिवस तुझे हे फुलायचे, शुक्रतारा मंद वारा हि आणि यासारखी त्यांची अनेक गीते लोकप्रिय आहेत.



माझ्यापुरते बोलायचे झाल्यास शाळेच्या पाठ्यपुस्तकातून त्यांची कविता मला पहिल्यांदा भेटली. त्या शब्दांचा, भाषेचा माझ्या बाल-मनावर असा परिणाम झाला की पुढचे अनेक दिवस मी ती कविता वारंवार स्वतःशी म्हणत होते. पुढे आयुष्याच्या वेगवेगळ्या वळणावर त्यांची कविता मला पुन्हा पुन्हा भेटत राहिली. प्रत्येकवेळी वेगवेगळे अर्थ तिच्यातून मला सापडू लागले. माझ्या जगण्याशी ही कविता कधी जोडली गेली हे माझे मला सुद्धा कळले नाही. आज कविवर्य मंगेश पाडगावकर आपल्यात नसतील पण त्यांची ही कविता माझ्यासारख्या अनेकांच्या मनात, हृदयात कायम जिवंत राहिल -

“शब्द शब्द जपून ठेव, बकुळीच्या फुलापरी
काय बोलले न कळे, तू समजून घे सगळे
लाविलीस ज्योत तूच या उदास अंतरी
दुःख नको तुटताना, अश्रू नको वळताना
मी मिटता लोचन हे उमलशील तू उरी”



यशदा आघारकर

ExTC Department



नैराश्याची ऐशी तैशी.....

रमत गमत चालले होते आयुष्याच्या वाटेवर
 अचानक एक दिवस निराशा भेटली हळच एका वळणावर
 मला म्हणाली 'अग मी तर तुझीच मैत्रीण'
 हाताला धरून चालत होती
 वाटेत भेटणाऱ्या प्रत्येकाला हेच सांगत होती
 चालत चालत बरीच दूर आली
 येताना दुःख, यातना वेचत आली
 मी पण सच्च्या दोस्ताप्रमाणे तिच्यासाठी त्यागला माझा आनंद, माझा
 आत्मविश्वास, त्यागली जुनी नाती
 एक दिवस लक्षात आलं, अरे हि तर नाही माझी
 मैत्रीणीच्या बुरख्याखाली दडलेली एक काळीकूठ सावली
 मग...मग मी झटकन दिला तिचा हात
 म्हटलं, तुझे बघितले खायचे दात
 भरला आत्मविश्वास, धरले जुन्या सवंगड्यांचे घट्ट हात
 आणि तिला म्हटलं, आता परत येशील तर याद राख
 तेव्हा ती घाबरली, माझं चुकलं मला माफ कर म्हणाली
 मी परत येणार नाही, तुला परत फसवणार नाही
 मी म्हटलं, आता भरपूर आत्मविश्वास आहे माझ्यात
 माझं काहीच बिघडेव शकणार नाहीस अशात
 तेव्हापासून ती आली नाही,
 आणि मी मागे वळून पहिल नाही
 म्हणून सांगते मित्रानो, आत्मविश्वासच बळ भरा पंखात
 आणि गरुडाची झेप घ्या उंच आकाशात
 निराशा जमिनीवर राहून जाईल
 दुःख तिच्याबरोबर विरून जाईल
 राहिल तुमच्या बरोबर फक्त तुमचा आनंद आणि अपार आत्मविश्वास

- गौरी देशपांडे (M.E .EXTC)

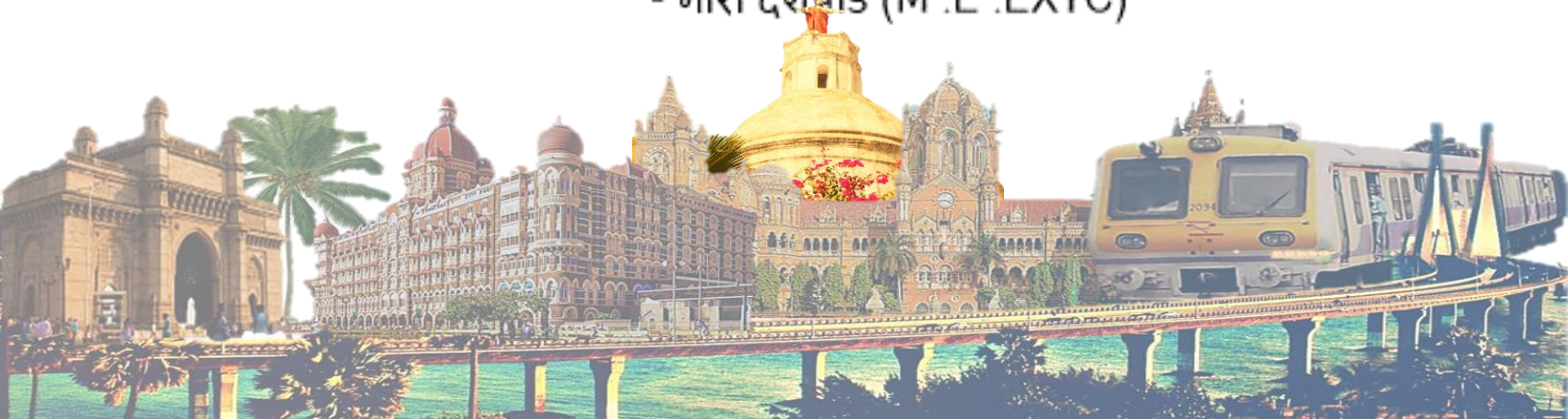

आमची मुंबई

सात चिमुकल्या मैत्रिणींनी समुद्रात फेर धराला. सातही जणी आम्ही मैत्रीच्या धाग्यांनी जवळ आलो आणि आमचं एक छोटसं विश्वच तयार झालं. सागराच्या अथांग किनारी आम्ही फुललो बहरलो.

तुमच्या सर्वांच्या स्वप्नांची पूर्तता करणारी मुंबई

तुमची स्वप्ननगरी मुंबई

भल्याभल्यांना मोहात पाडणारी मायानगरी मुंबई

लखलखती चंदेरी नगरी मुंबई

मरीन ड्राईव्हचा नेकलेस दिमाखाने गळ्यात मिरावणारी मुंबई

आणि तितक्याच आपुलकीने फुटपाथवरच्या संसारही आपलासा म्हणणारी मुंबई

उत्तुंग इमारतींनी आकाशाला कवेत घेणारी आलिशान मुंबई

फॅशनची रंगरंगीली वस्त्रे परिधान करणारी मुंबई

फॅशन नगरी मुंबई, बॉलीवूडची पंढरी मुंबई

ढोल ताश्याच्या गजरात गणरायाचे स्वागत करणारी मुंबई

'मारो गरबो रमतो जाय' म्हणत दांडिया खेळत नवरात्र जागवणारी मुंबई

उत्साहाने सळसळणारी, चैतन्याने बहरलेली, अहोरात्र जागी असलेली मुंबई

पायाला चाक लाऊन फिरणारी मुंबई

.घडयाळ्याच्या काट्याची बरोबरी करण्यासाठी जीवाचा आटापिटा करणारी मुंबई

घोडगाडीच्या टापांचा आवाज अजूनही कानात घुमतोय म्हणणाऱ्यांची, ऐतिहासिक मुंबई

राजकारण्यांची मुंबई, कामगारांची मुंबई

अगदी भिकान्यांची सुद्धा मुंबई

महाराष्ट्राची राजधानी मुंबई

प्रलयकारी मुंबई

प्रदूषणाच्या विळख्यात अडकत चाललेली मुंबई

झोपड्यांचा फास गळ्याभोवती आवळत चाललेली मुंबई

सामना करणारी मुंबई

मांसाहार करावा की करू नये ह्यासाठी वाद घालणारी मुंबई

जात पात धर्म पंथ भेद विसरून लाखो मदतीचे हात पुढे करणारी मुंबई



आपलं बरं आणि आपल काम बरं म्हणत आपल्या मस्तीत दंग असलेल्या फ्लॉट संस्कृतीची मुंबई

मुंबई नक्की कोणाची ? मदतीसाठी पुढे सरसावणारी की लोकलच्या चौथ्या सीटसाठी कचा-कचा भांडणारी मुंबई

मुंबईची ही अनेक विविध रूप मला भावलेली , तुम्हाला कोणत भावतं ते तुम्हीच ठरवा कारण मुंबई ही माझी , तुमची , सर्वांची, आमची मुंबई!!!



निषाद मेहेंदळे

SE CMPN A



रवींद्रनाथ टागोरांचे सुंदर विचार

प्रिय देवास,

विपत्तीमध्ये तू माझं रक्षण कर, ही माझी प्रार्थना नाही
विपत्तीमध्ये मी भयभित होऊ नये एवढीच माझी इच्छा

दुख:तापाने व्यथित झालेल्या माझ्या मनाच तू सांत्वन करावस अशी माझी
अपेक्षा नाही

दुःखावर जय मिळवता यावा एवढीच माझी इच्छा

जगात माझं नुकसान झालं, केवळ फसवणूकच वाट्याला आली
तर माझं मन खंबीर राहावं एवढीच माझी इच्छा

माझं रक्षण तू करावस, मला तारावस ही माझी प्रार्थना नाही,
तरुन जाण्याच सामर्थ्य माझ्यात असाव एवढीच माझी इच्छा

माझं ओझ हलक करून तू माझं सांत्वन केल नाहीस तरी माझी तक्रार नाही
ते ओझ वाहायची शक्ती मात्र माझ्यात असावी एवढीच माझी इच्छा

सुखाच्या दिवसात नतमस्तक होऊन मी तुझा चेहरा ओळखून काढीन दुःखाच्या रात्री
सारं जग जेव्हा माझी फसवणूक करील तेव्हा तुझ्याविषयी माझ्या मनात शंका निर्माण
होऊ नये एवढीच माझी इच्छा!



संग्रह : समिता संजय काणेकर
ExTC Department



ART TROVE



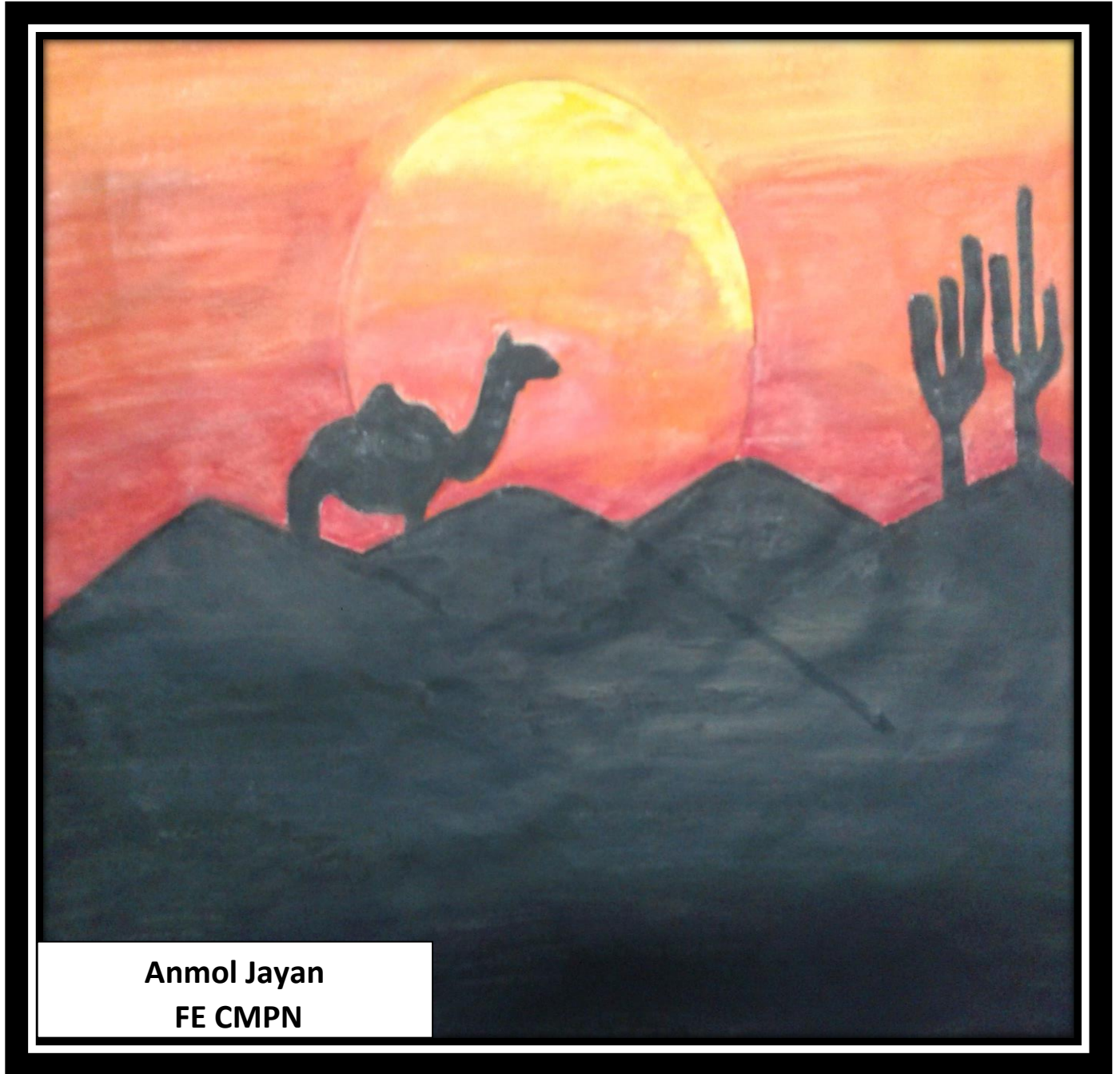

Anmol Jayan
FE CMPN



**Avril Lopes
FE CMPN A**



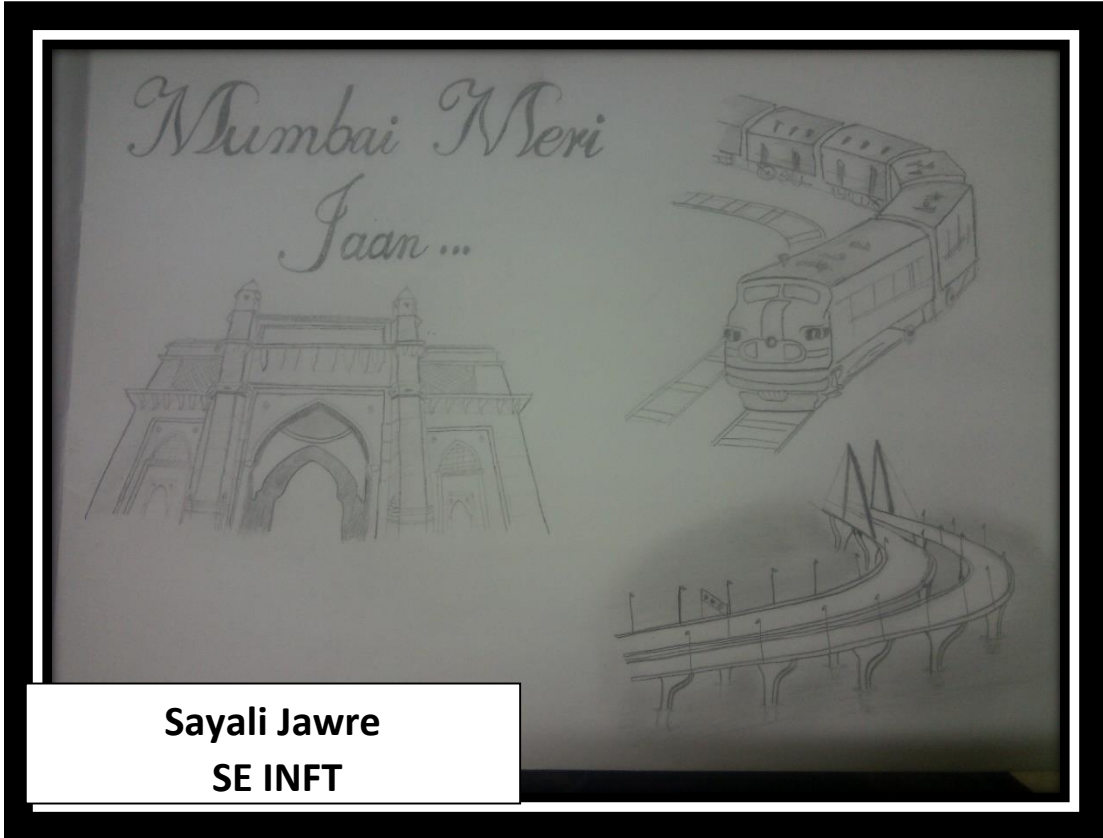

Sayali Jawre
SE INFT



Avril Lopes
FE CMPN A



Caroline Lopes
FE CMPN A





Prathmesh Borlikar
BE CMPN A

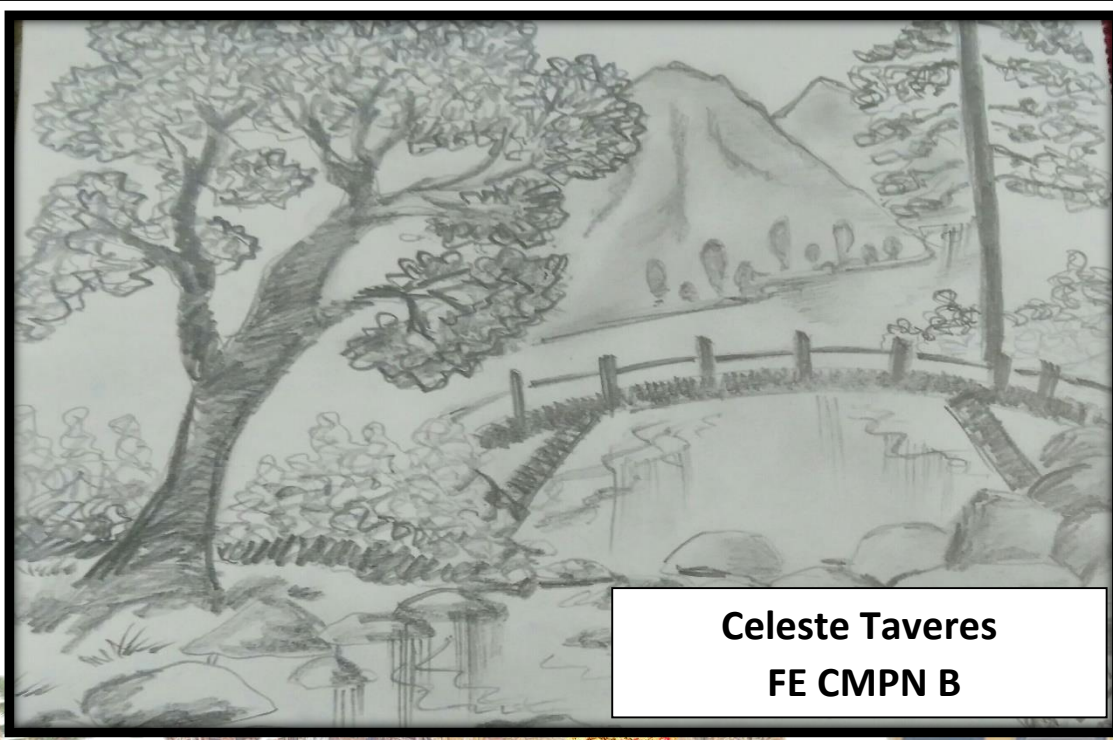

Celeste Taveres
FE CMPN B





Tina Menezes
BE CMPN A



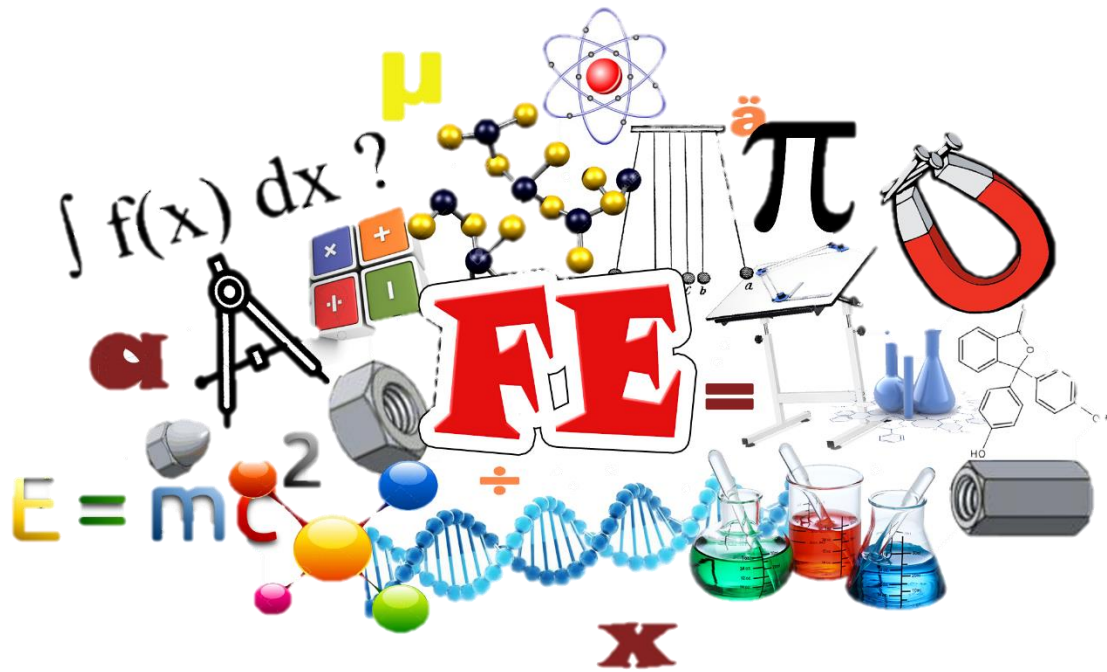

Fe

SCIENCE & HUMANITIES



DR. POONAM HEMNANI
ASSOCIATE PROFESSOR
PH.D., M.Sc. (ORGANIC CHEMISTRY)

DEPARTMENT PHOTO



1. A SEMINAR ON “NEW CHALLENGES IN PEDAGOGY” WAS ARRANGED ON 17/01/15 FOR ALL FE TEACHERS. THE RESOURCE PERSON FOR SEMINAR WAS DR. (MRS.) GEETA SHETTY.
2. SEMINAR FOR FE STUDENTS ON “ROLE & VALUE OF ENGINEERS AND CURRENT INDUSTRY SCENARIO” WAS ARRANGED ON 18/3/15 BY TPO.
3. “PRAYAS – A PROJECT EXHIBITION” WAS HELD ON 4TH MARCH, 2015. IT WAS A SUCCESSFUL ISTE APPROVED EVENT WHERE FE STUDENTS SHOWCASE THEIR PROJECT IDEAS.
4. “E-Cell Day” WAS CELEBRATED ON 07/03/15 FOR FE STUDENTS, FOR THIS A SEMINAR AS WELL AS WORKSHOP WAS ARRANGED.
5. A WORKSHOP ON CHN (COMPUTER HARDWARE & NETWORKING) WAS CONDUCTED BY MR. SANDEEP SHETAGE FOR FE STUDENTS (FROM 15/6 TO 23/06).
6. A WORKSHOP FOR LAB ASSISTANTS WAS ARRANGED ON 7TH JULY, 2015 TO GIVE PRACTICE ON LATEST APPLICATIONS OF MS OFFICE.
7. MR. M K BYSANI ATTENDED TWO - WEEK ISTE SHORT TERM TRAINING PROGRAM (STTP) ON PEDAGOGY FOR EFFECTIVE USE OF ICT IN ENGINEERING EDUCATION , JANUARY 1 – 5, 8- 18, 2015 BY NATIONAL MISSION ON EDUCATION THROUGH ICT (MHRD).
8. Ms. Rujata Chaudhari and Ms. Pradhnya Pradhan joined the department as

ST. FRANCIS INSTITUTE OF TECHNOLOGY
BASIC SCIENCES AND HUMANITIES DEPARTMENT
presents
An ISTE Chapter (MH-202) approved
science and technology project exhibition

PRAYAS
An Attempt by F.E. Students...
on 4th March, 2015 at 1:00pm in the Assembly hall

*Students of First Year will integrate the knowledge of different
subjects which they are studying and try out their
PRACTICAL APPLICATIONS...*

FE Faculty Achievements

<p>DR. C. HARI PRASAD</p>	<p>ATTENDED A SEMINAR ON <u>INTRODUCTION TO STRUCTURAL ENGINEERING</u> AT IIT KAHARAGPUR FROM 28 SEPTEMBER 2015 TO 02 OCTOBER 2015</p>
<p>Ms Rekha Ajikumar</p>	<p>ATTENDED THE ISTE APPROVED STTP ON <u>ENGINEERING PHYSICS</u> CONDUCTED BY IIT BOMBAY FROM 8 DECEMBER 2015 TO 18 DECEMBER 2015</p> <p>ATTENDED A WORKSHOP ON <u>STRUCTURE SOLVING BY POWDER X-RAY DIFFRACTION</u> AT THE ROYAL COLLEGE OF SCIENCE ON 28-29 NOVEMBER 2015</p> <p>INVITED AS A RESOURCE PERSON FOR A SESSION ON <u>MICRO TEACHING AT FACULTY INDUCTION PROGRAMME 2015</u> AT ST. FRANCIS INSTITUTE OF TECHNOLOGY ON 9 - 10 JULY 2015</p>
<p>Ms BEATRICE Lobo</p>	<p>COORDINATED AND ATTENDED THE ISTE APPROVED STTP ON <u>TECHNICAL COMMUNICATION FOR SCIENTISTS AND ENGINEERS</u> CONDUCTED BY IIT BOMBAY FROM 31 NOVEMBER 2015 TO 05 DECEMBER 2015</p>
<p>Ms ARTI BHATNAGAR</p>	<p>ATTENDED A REFRESHER COURSE ON <u>COMPUTATIONAL METHODS IN BASIC SCIENCES</u> AT THE UNIVERSITY OF MUMBAI FROM 16 NOVEMBER 2015 TO 05 DECEMBER 2015</p>



<p>MR RAVINDRA GARMODE</p>	<p>ATTENDED THE ISTE APPROVED STTP ON <u>TECHNICAL COMMUNICATION FOR SCIENTISTS AND ENGINEERS</u> CONDUCTED BY IIT BOMBAY FROM 31 NOVEMBER 2015 TO 05 DECEMBER 2015</p>
<p>MS PREETI COLACO</p>	<p>ATTENDED THE ISTE APPROVED STTP ON <u>ENGINEERING PHYSICS</u> CONDUCTED BY IIT BOMBAY FROM 8 DECEMBER 2015 TO 18 DECEMBER 2015</p> <p>INVITED AS A RESOURCE PERSON FOR A SESSION ON <u>MICRO TEACHING AT FACULTY INDUCTION PROGRAMME 2015</u> AT ST. FRANCIS INSTITUTE OF TECHNOLOGY ON 9 - 10 JULY 2015</p>
<p>MS BELINDA MISQUITTA</p>	<p>ATTENDED THE ISTE APPROVED STTP ON <u>TECHNICAL COMMUNICATION FOR SCIENTISTS AND ENGINEERS</u> CONDUCTED BY IIT BOMBAY FROM 31 NOVEMBER 2015 TO 05 DECEMBER 2015</p>
<p>MS ASTRID D'SOUZA</p>	<p>ATTENDED THE ISTE APPROVED STTP ON <u>TECHNICAL COMMUNICATION FOR SCIENTISTS AND ENGINEERS</u> CONDUCTED BY IIT BOMBAY FROM 31 NOVEMBER 2015 TO 05 DECEMBER 2015</p>
<p>MR BYSANI MALKONDAIAH</p>	<p>ATTENDED A WORKSHOP ON <u>PEDAGOGY FOR EFFECTIVE USE OF ICT IN ENGINEERING EDUCATION</u> CONDUCTED UNDER NATIONAL MISSION ON EDUCATION THROUGH ICT (MHRD), IIT BOMBAY</p> <p>ATTENDED THE ISTE APPROVED STTP ON <u>TECHNICAL</u></p>



	COMMUNICATION FOR SCIENTISTS AND ENGINEERS conducted by IIT Bombay from 31 November 2015 to 05 December 2015
Mr Utkal Jadhav	MEMBER OF THE ORGANIZING COMMITTEE FOR FACULTY INDUCTION PROGRAMME 2015 held at St. Francis Institute of Technology from 1 July 2015 to 10 July 2015
Ms DEEPA PANAKKAL	<p>ATTENDED THE ISTE APPROVED STTP ON <u>TECHNICAL COMMUNICATION FOR SCIENTISTS AND ENGINEERS</u> conducted by IIT Bombay from 31 November 2015 to 05 December 2015</p> <p>INVITED AS A RESOURCE PERSON TO CONDUCT A SESSION ON <u>ADOLESCENT PSYCHOLOGY</u> AT FACULTY INDUCTION PROGRAMME 2015 AT ST. FRANCIS INSTITUTE OF TECHNOLOGY ON 9 July 2015</p>
Ms RENITA D'SOUZA	<p>ATTENDED THE ISTE APPROVED STTP ON <u>TECHNICAL COMMUNICATION FOR SCIENTISTS AND ENGINEERS</u> conducted by IIT Bombay from 31 November 2015 to 05 December 2015</p> <p>ATTENDED THE FACULTY INDUCTION PROGRAMME 2015 AT ST. FRANCIS INSTITUTE OF TECHNOLOGY FROM 1 July 2015 TO 10 July 2015</p>



<p>Ms Rachel Pereira</p>	<p>ATTENDED THE FACULTY INDUCTION PROGRAMME 2015 AT ST. FRANCIS INSTITUTE OF TECHNOLOGY FROM 1 JULY 2015 TO 10 JULY 2015</p>
<p>Ms Princy Chacko</p>	<p>ATTENDED THE ISTE APPROVED STTP ON <u>TECHNICAL COMMUNICATION FOR SCIENTISTS AND ENGINEERS</u> CONDUCTED BY IIT BOMBAY FROM 31 NOVEMBER 2015 TO 05 DECEMBER 2015</p>
<p>Ms Rajshree Lisham</p>	<p>ATTENDED THE ISTE APPROVED STTP ON <u>TECHNICAL COMMUNICATION FOR SCIENTISTS AND ENGINEERS</u> CONDUCTED BY IIT BOMBAY FROM 31 NOVEMBER 2015 TO 05 DECEMBER 2015</p> <p>ATTENDED THE FACULTY INDUCTION PROGRAMME 2015 AT ST. FRANCIS INSTITUTE OF TECHNOLOGY FROM 1 JULY 2015 TO 10 JULY 2015</p>
<p>Ms Sebatini Almeida</p>	<p>ATTENDED THE FACULTY INDUCTION PROGRAMME 2015 AT ST. FRANCIS INSTITUTE OF TECHNOLOGY FROM 1 JULY 2015 TO 10 JULY 2015</p>
<p>MR SAINATH GOSALKAR</p>	<p>ATTENDED THE FACULTY INDUCTION PROGRAMME 2015 AT ST. FRANCIS INSTITUTE OF TECHNOLOGY FROM 1 JULY 2015 TO 10 JULY 2015</p>





FE Cmpn A



FE Cmpn B





FE INFIT A



FE INFIT B





FE EXTC A



FE EXTC B





COMPUTER ENGINEERING



Ms. Bidisha Roy

HOD of COMPUTERS, ASSOCIATE PROFESSOR

M.E (COMPUTER), B.E (EXTC)

DEPARTMENT PHOTO

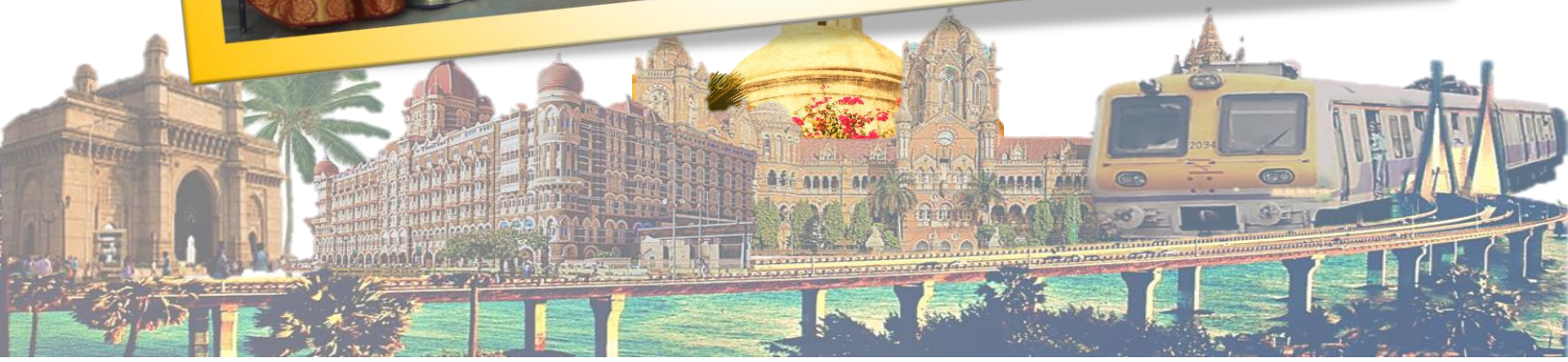

Staff Activities

1. **DR. KAVITA SONAWANE - RECEIVED Ph.D. DEGREE FROM NMIMS UNIVERSITY ON 1ST April 2015. THESIS TITLE: Bins Approach To CBIR**
2. **Ms. Bidisha Roy, Ms. ANURADHA G., AND Ms. DAKSHATA PANCHAL ARE PURSUING Ph.D.**
3. **Ms. Nidhi GAUR, Ms. Sridari Iyer, Ms. JAYASHRI MITTAL, Ms. VARSHA NAGPURE, Ms. ANKITA KARIA, MR. RUPESH MISHRA, MR. ASLAM NANDYAL, Ms. PRADHNYA PRADHAN, Ms. RUJATA CHAUDHARI, Ms. PRIYANCA GONSALVES, Ms. VARSHA SHRIVASTAVA, MR. JERIN THANKAPPAN AND MR. NATHAN DLIMA – ATTENDED TWO-WEEK ISTE STTP ON TECHNICAL COMMUNICATION CONDUCTED BY IIT BOMBAY AT SFIT CAMPUS, FROM 30TH Nov – 05TH DEC 2015.**
4. **GALITZ'S HUMAN MACHINE INTERACTION WAS ADAPTED BY DR. DHANANJAY KALBANDE, MR. PRASHANT KANADE, Ms. Sridari Iyer (ASST. PROFESSOR - SFIT).**

Staff Publications

FACULTY	DATE	PAPER TITLE	DETAILS
KAVITA SONAWANE	AUG 2015	SECURE DATA TRANSMISSION USING VIDEO	EIGHTH INTERNATIONAL CONFERENCE ON CONTEMPORARY COMPUTING., 20-22 AUG 2015, 978-1-4673-7948-9/15 IEEE Xpolre (ACCEPTANCE IN 25% OF ALL PAPERS)
PRADHNYA PRADHAN	JULY 2015	DESIGNING MULTICAST WIRELESS SENSOR NETWORK	LAMBERT ACADEMIC PUBLISHING, ISBN: 978-3-659-74833-2 pg. 1-37.



PRIYANCA FARGOSE	July 2015	Daily WEATHER FORECASTING USING ARTIFICIAL NEURAL NETWORK	INTERNATIONAL JOURNAL of COMPUTER Applications, Vol.121(22), pp. 9-13, ISBN 73-93-80887-98-0
SWEEDLE MASCARENES	Sep 2015	“DEVELOPMENT of Web GIS FRAMEWORK for INDIAN TECHNICAL INSTITUTES USING OPEN SOURCE GIS TOOLS”	IEEE INTERNATIONAL CONFERENCE ON COMPUTER COMMUNICATION AND CONTROL.

Student Achievements

A)PRESENTATION COMPETITION held AT FR. CONCEICAO RODRIQUES COLLEGE of ENGINEERING, ON 28 AUGUST 2015, 3rd place winners

NAME OF THE STUDENTS

Achilles RASQUINHA
UNNATI GUHA
MANASI VAIDYA
DIVYA DAVE

B) Citywide PARLIAMENTARY DEBATE “Off’d Cuff” AT THE HR COLLEGE of COMMERCE AND ECONOMICS, 1SEPT.2015, ELIMINATION ROUNDS

Name of the Students

Unnati Guha
Divya Dave

C) NATIONAL LEVEL Oxford DEBATE AT THE FR. CONCEICAO RODRIQUES COLLEGE of ENGINEERING, 11 – 12 SEPT 2015,

NAME OF THE STUDENTS

- 1) DANIEL D’SOUZA (BEST SPEAKER)
- 2) Achilles RASQUINHAS





BE Cmpn A



BE Cmpn B





Te CMPN A



Te CMPN B





SE CMPN A



SE CMPN B





ELECTRONICS & TELECOMMUNICATION



DR. GAUTAM SHAH
PROFESSOR, HOD
PH. D (ENGINEERING),
M. E. (DIGITAL TECHNIQUES & INSTRUMENTATION),
B.E. (ELECTRONICS)

DEPARTMENT PHOTO



NAME OF THE FACULTY	ACHIEVEMENTS AND AWARDS
MR. SANTOSH CHAPANERI MS. RENIA LOPES AND DR. DEEPAK JAYASWAL	BEST PAPER AWARD FOR THE PAPER TITLED "EVALUATION OF MUSIC FEATURES FOR PUK KERNEL BASED GENRE CLASSIFICATION" PRESENTED IN ICACTA AND PUBLISHED IN ELSEVIER JOURNAL IN MARCH 2015.
DR. KEVIN NORONHA	RECEIVED PH.D. DEGREE FROM MANIPAL UNIVERSITY ON 16 APRIL, 2015. THESIS TITLE: AUTOMATED IDENTIFICATION OF DIABETIC EYE DISEASES USING DIGITAL FUNDUS IMAGE
MS. PURNIMA CHANDRASHEKHAR, MS. SHRUTI DHAMANKAR, MS. AFREEN ZEHRA SAYED AND MR. NELSON AGERA	RECEIVED M.E DEGREE IN THE ACADEMIC YEAR 2014-2015.

NAME OF THE FACULTY	ACTIVITIES
MS. JAYASUDHA KOTI	ORGANIZED AND ATTENDED WORKSHOP ON NS2 AT SFIT WHICH WAS HELD ON 23/01/15 & 24/01/15.
MS. KAVITA SAKHARDANDE	ATTENDED WORKSHOP FOR CYPRESS PSOC KITS BY EDUVANCE AT SFIT, FEB 7, 2015.
MR. SANTOSH CHAPANERI	ATTENDED QIP ON ADVANCES IN SIGNAL PROCESSING AT VJTI, FEB 23 - 27, 2015.
MR. IDERKUMAR KOCHAR	ATTENDED QIP ON ADVANCES IN SIGNAL PROCESSING AT VJTI, FEB 23 - 27, 2015.
MS. SAVITA KULKARNI	WORKSHOP FOR CYPRESS PSOC KITS BY EDUVANCE AT SFIT, FEB 7, 2015.



Ms. Afreen Sayed	ATTENDED ONE DAY HANDS ON TRAINING WORKSHOP ON CCN AT SPIT, FEB 7, 2015.
Ms Nikita Patni	Workshop for Cypress PSOC kits by EDUVANCE AT SFIT, FEB 7, 2015
Ms. Shruti Dhamankar	ATTENDED WORKSHOP ON NS2 AT SFIT WHICH WAS HELD ON 23/01/15 & 24/01/15.

Workshops/SEMINARS /CONFERENCE CONDUCTED			
SR.NO	DATE	TITLE OF WORKSHOP/SEMINAR/ CONFERENCE	ORGANIZING Body
GAUTAM SHAH			
1	JUL-15	CONDUCTED SESSION ON "COURSE FILE COMPILATION AND RUBRIC DESIGN TECHNIQUES FOR OUTCOME EVALUATION IN THE 1 WEEK STTP ON 'FACULTY INDUCTION PROGRAM'	SFIT, Mumbai
Workshops/SEMINARS /CONFERENCE ATTENDED			
SR.NO	DATE	TITLE OF WORKSHOP/SEMINAR/ CONFERENCE	ORGANIZING Body
RAVINDRA C.			
1	JUL-15	FACULTY INTERACTION PROGRAM ON ELEMENTS OF MICROELECTRONICS SUBJECT	
KEVIN NORONHA			
1	OCT-15	ONE WEEK WORKSHOP ON "NEXT GENERATION NETWORKS"	CETTM, Mumbai
MONICA C			



1	DEC-15	INTERNATIONAL CONFERENCE ON COMPUTATIONAL INTELLIGENCE AND COMMUNICATION NETWORKS	IEEE, CICON Jabalpur
1	SEP-15	INTERNATIONAL CONFERENCE ON ADVANCES IN COMMUNICATION AND COMPUTING	IEEE, ICACC Kochi
Shilpa C			
1	DEC-15	TWO WEEK STTP ON "ENGINEERING PHYSICS"	IIT Bombay
2	AUG-15	2 days workshop ON "ARM , ARM CORTEX AND RTOS"	SPIT, ANDHERI
3	JUL-15	1 WEEK STTP, "FACULTY DEVELOPMENT PROGRAMME-2015"	SFIT, Mumbai
AFREENZEHRA S			
1	SEP-15	ROBOTICS WORKSHOP ORGANIZED BY ARK TECH & ROBOCART.COM IN ASSOCIATION WITH AMALGAM, IIT MADRAS ON 12TH AND 13TH SEPT 2015	ISTE
2	AUG-15	GOOGLE APP WORKSHOP BY MR. YOGESH MODAK AT 29TH AUGUST 2015, SFIT, MUMBAI	SFIT, Mumbai
SHRUTI D			
1	DEC-15	TWO WEEK STTP ON "ENGINEERING PHYSICS"	IIT Bombay
2	AUG-15	GOOGLE APP WORKSHOP BY MR. YOGESH MODAK AT 29TH AUGUST 2015, SFIT, MUMBAI	SFIT, Mumbai
JOVITA S			
1	DEC-15	ONE WEEK WORKSHOP ON "CMOS ANALOG VLSI DESIGN"	SPIT, Mumbai
2	DEC-15	TWO WEEK STTP ON "TECHNICAL COMMUNICATION"	ISTE, IIT Bombay
3	OCT-15	IEEE INTERNATIONAL CONFERENCE ON ENERGY SYSTEMS AND APPLICATION	IEEE, ICESA
4	AUG-15	IETE NATIONAL CONFERENCE ON NASCENT & ADVANCED TECHNOLOGIES	IETE, NCNAT
5	AUG-15	GOOGLE APP WORKSHOP BY MR. YOGESH MODAK	SFIT, Mumbai
RAMJEE Y			
1	AUG-15	E-SIM FACULTY MEET	FOSSEE, IIT Bombay

2	Aug-15	Google App Workshop by Mr. Yogesh Modak	SFIT, Mumbai
3	Jul-15	1 week STTP, "Faculty Development Programme-2015"	SFIT, Mumbai
SNEHAL lopes			
1	DEC-15	Two week STTP ON "ENGINEERING Physics"	IIT Bombay
2	Aug-15	eSim Faculty Meet	FOSSEE, IIT Bombay
3	Aug-15	Google App Workshop by Mr. Yogesh Modak	SFIT, Mumbai
Nikita Jain			
1	DEC-15	ONE WEEK WORKSHOP ON "CMOS ANALOG VLSI DESIGN"	SPIT, Mumbai
2	Aug-15	eSim Faculty Meet	FOSSEE, IIT Bombay
SANDIP DHENDE			
1	DEC-15	Two week STTP ON "ENGINEERING Physics"	IIT Bombay
2	Jul-15	1 week STTP, "Faculty Development Programme-2015"	SFIT, Mumbai
PURNIMA CHANDRASHEKHAR			
1	DEC-15	Two week STTP ON "TECHNICAL COMMUNICATION"	ISTE, IIT Bombay
2	Aug-15	Google App Workshop by Mr. Yogesh Modak	SFIT, Mumbai
JAY MEHTA			
1	DEC-15	Two week STTP ON "TECHNICAL COMMUNICATION"	ISTE, IIT Bombay
2	DEC-15	Two week STTP ON "ENGINEERING Physics"	IIT Bombay
NELSON AGERA			
1	DEC-15	Two week STTP ON "TECHNICAL COMMUNICATION"	ISTE, IIT Bombay
2	OCT-15	ONE WEEK WORKSHOP ON "NEXT GENERATION NETWORKS"	CETTM, Mumbai
3	SEP-15	PYTHON WORKSHOP	IEEE, SFIT
4	Aug-15	Google App Workshop by Mr. Yogesh Modak	SFIT, Mumbai

VADAR ANSARI

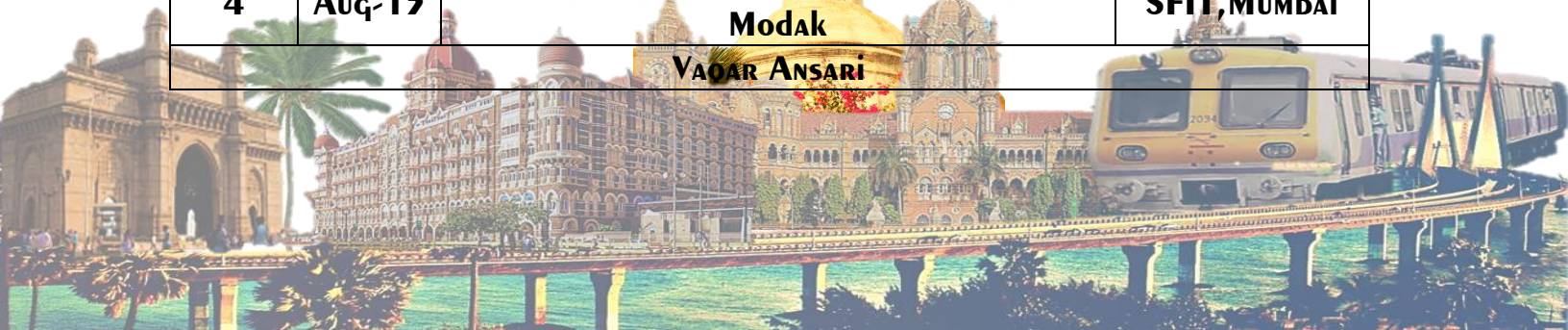

1	DEC-15	TWO WEEK STTP ON "TECHNICAL COMMUNICATION" QUANITAH SHAIKH	ISTE, IIT Bombay
1	SEP-15	ROBOTICS WORKSHOP ORGANIZED BY ARK TECH & ROBOCART.COM IN ASSOCIATION WITH AMALGAM, IIT MADRAS ON 12TH AND 13TH SEPT 2015	ISTE
2	AUG-15	eSIM FACULTY MEET	FOSSEE, IIT Bombay

Student Achievements

1) CITYWIDE PARLIAMENTARY DEBATE "OFF'D CUFF" AT THE HR COLLEGE OF COMMERCE AND ECONOMICS, 1 SEPT 2015, FIRST PLACE WINNERS

NAME OF THE STUDENTS

- 1) DANIEL D'SOUZ
- 2) AISHWARYA BALWANI

2) NATIONAL LEVEL OXFORD DEBATE AT THE FR. CONCEICAO RODRIGUES COLLEGE OF ENGINEERING, 11 – 12 SEPT 2015, FIRST PRIZE WINNERS, DANIEL AWARDED BEST SPEAKER

NAME OF THE STUDENTS

- 1) DANIEL D'SOUZA
- 2) ACHILLES RASQUINHAS





BE EXTC B



BE EXTC A





Te Extc A



Te Extc B





SE EXTC A



SE EXTC B



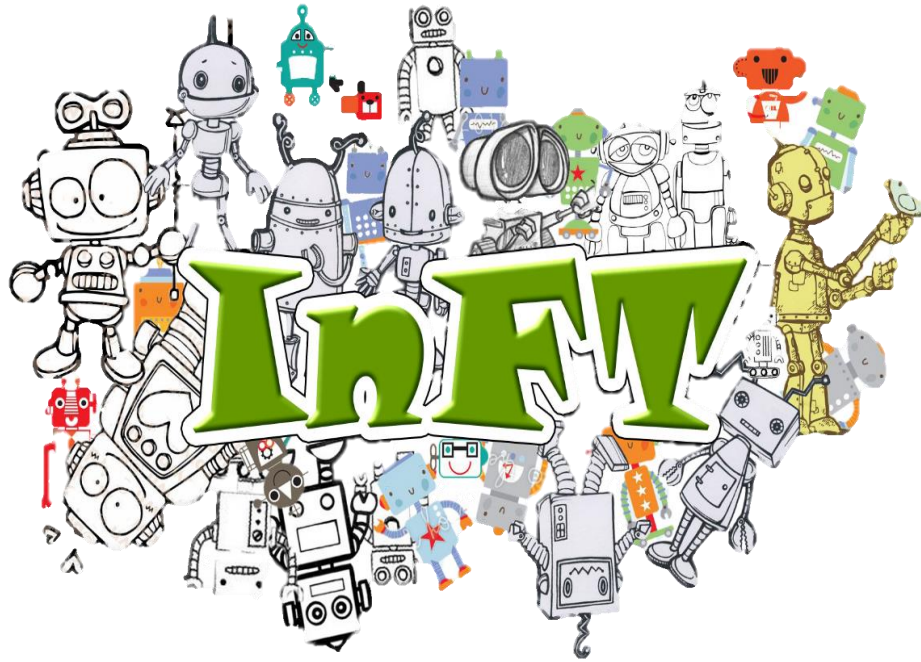

INFORMATION TECHNOLOGY



Mr. Pramod Shanbhag

HOD, Associate Professor
MS (Electrical Engineering),
BE (EXTC)

DEPARTMENT PHOTO



INFORMATION TECHNOLOGY STUDENTS ASSOCIATION

INFORMATION TECHNOLOGY STUDENTS ASSOCIATION (ITSA) WAS FOUNDED IN 2012. ITS MISSION IS TO CREATE LEADERSHIP OPPORTUNITIES IN TECHNOLOGY, INNOVATION, DESIGN AND ENGINEERING. TO APPLY STEM (SCIENCE, TECHNOLOGY, ENGINEERING AND MATHEMATICS) CONCEPTS THROUGH CO-CURRICULAR PROGRAMS.

STAFF CO-ORDINATOR: Ms. MRINMOYEE MUKHERJEE

JOINT CO-ORDINATOR: Ms. SONALI VAIDYA

ITSA ACTIVITIES

DATE	SEMINAR/WORKSHOP/CONTEST	CONDUCTOR
1ST April	SEMINAR ON ADVANCE INTERNET TECHNOLOGY	Ms. JINU VARGESE
April 6TH & 8TH, 2015	STUDY OF PC ASSEMBLING	MR. MITESH GUPTA AND ANUJ POTDAR(SFIT INFT STUDENTS)
15TH April 2015	SEMINAR ON STORAGE AREA NETWORK	MR. ANSHUMAN RAI (GUEST SPEAKER EMC)
28 MARCH 2015	WEAVE THE WEB COMPETITION	1ST PRIZE: JASON DIAS AND ANJALI HEMMADI



		2ND PRIZE: NATALINA RODRIGUES AND NATASHA REGO
7TH AND 8TH MARCH 2015	SYSTEM SECURITY , Web SECURITY AND ETHICAL HACKING	SKYNET SECURE.
9TH SEPTEMBER, 2015	MICROSOFT AZURE	MR. Ashish JAGDALE AND MR. MIHIR KADAM

INDUSTRIAL VISITS by ITSA

CEDAC, PUNJAB TRACTOR/SWARAJ MAZDA (KULU MANALI – CHANDIGARH)

MPRO INDUSTRIES IT DEPARTMENT ON 2ND MARCH, 2015

STAFF ACTIVITIES

- 1. Ms. MRINMOYEE MUKHERJEE WAS FIP-2015 CONVENER ALONG WITH DR. KAVITA SONAWANE.**
- 2. DR. JOANNE GOMES AND Ms.PURNIMA KUBDE ATTENDED ONE WEEK AICTE-ISTE APPROVED STTP PROGRAM ON “WIRELESS NETWORKS AND COGNITIVE RADIO”, HELD ON 9TH MARCH 2015 AT VJTI (DADAR).**
- 3. Ms. NAZNEEN ANSARI, Ms. SONALI VAIDYA , MR. VAIBHAV KALA AND MR. BHAVESH PANDYA ATTENDED A 2 WEEKS ISTE-STTP PROGRAM ON “ADVANCES IN CLOUD COMPUTING” HELD FROM 15TH JUNE TO 26TH JUNE 2015 AT TSEC (BANDRA).**
- 4. Ms. VANDANA PATIL, Ms. GRINAL MENEZES, Ms. PURNIMA KUBDE, Ms. SONALI VAIDYA AND MR. BHAVESH ATTENDED A TWO WEEK TEQUIP ON “INTRODUCTION TO DESIGN OF ALGORITHM”, CONDUCTED BY IIT KHARAGPUR AT SFIT FROM 27TH MAY 2015 TO 30TH MAY 2015.**

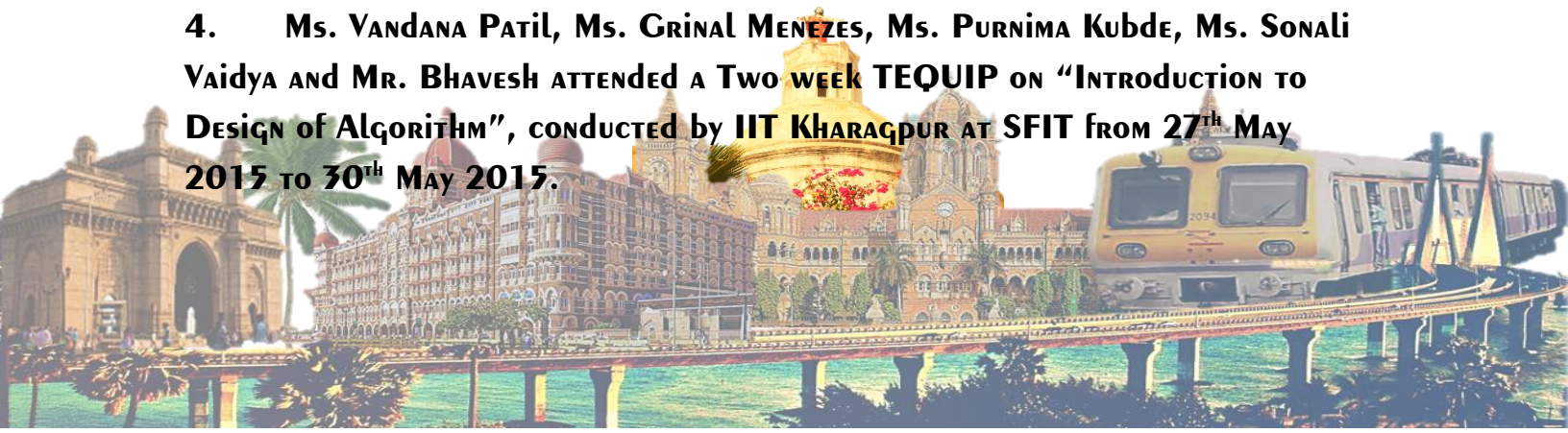

5. **Ms. GRINAL MENEZES, Ms. AMRITA MATHUR, Ms. PURNIMA Kubde Cloud Computing, Big DATA And Virtualization held on 10th April 2015 @ SFIT BY TCS.**
6. **Mrs. Nitika Rai attended a two – weeks workshop on ‘Modeling and Simulation of Mechatronics Systems Using MATLAB and Simulink’ started on 13th October ,2015.**
7. **Dr. Joanne Gomes , Mrs. Vandana Patil, Mrs Amrita Mathur and Mrs. Prajyoti Lopes attended two – weeks workshop on ‘ Technical Communication Modeling and Simulation of Mechatronics Systems Using MATLAB and Simulink’ conducted by IIT.**

Staff Publications

Ms. NAZNEEN ANSARI		
Vivian lobo AND NAZNEEN ANSARI	Multimedia Enabled VIRTUAL CLASSROOM FOR DISTANCE Education	INTERNATIONAL CONFERENCE ON GREEN Computing and INTERNET of THINGS (ICGCIoT 2015) , Greater Noida, India from 8–10 October 2015



MRS. VANDANA PATIL		
Tejal CARWALO, VANDANA PATIL	Ad-hoc Vehicle ROUTING PROBLEM	IEEE, INTERNATIONAL CONFERENCE ON GREEN COMPUTING AND INTERNET OF THINGS, 2015
Tejal CARWALO, VANDANA PATIL	Solving Vehicle ROUTING PROBLEM USING ANT COLONY OPTIMIZATION WITH Nodal DEMAND	INTERNATIONAL JOURNAL of ENGINEERING RESEARCH AND TECHNOLOGY(IJERT), Vol. 4, ISSUE 09 SEPTEMBER 2015,ISSN: 2278-0181.

MRS. SHREE JASWAL		
LISSA RODRIGUES AND SHREE JASWAL	Hybrid Model for IMPROVED PAGE RANKING ALGORITHM	IEEE INTERNATIONAL CONFERENCE ON CONTROL, INSTRUMENTATION, COMMUNICATION & COMPUTATIONAL TECHNOLOGIES (ICCICCT-2015)
HARSHA DAVE AND SHREE JASWAL	Multiple TEXT DOCUMENT SUMMARIZATION SYSTEM USING Hybrid SUMMARIZATION TECHNIQUE	1ST IEEE INTERNATIONAL CONFERENCE ON NEXT GENERATION COMPUTING TECHNOLOGIES(NGCT 2015)





BE Inft A



BE Inft B



Te Inft A



Te Inft B



SE Inft A



SE Inft B

FROM THE DESK OF THE DEAN ME PROGRAMME



DR DEEPAK JAYASWAL

PROFESSOR

PhD, M Tech (EXTC), B Tech (EXTC)

OUR MISSION AT SFIT IS TO IMPART HIGH QUALITY EDUCATION AND STRIVE TO PRODUCE EXCELLENT ACADEMIC DEVELOPMENT. HENCE, IT IS OUR RESPONSIBILITY TO EQUIP OUR STUDENTS AND FACULTY MEMBERS WITH UPGRADED KNOWLEDGE AND SKILLS SO THAT THEY CAN FACE GLOBAL CHALLENGES AS WELL AS ACQUIRE KNOWLEDGE TO DEVELOP OUR NATION. KEEPING THIS MISSION IN MIND, WE AT SFIT EXPOSE STUDENTS TO STATE-OF-THE-ART TECHNOLOGIES, IMBIBE ETHICAL AND PROFESSIONAL VALUES, AND INCULCATE THE QUEST FOR HIGHER LEARNING AND AN APTITUDE FOR RESEARCH AND GLOBAL COMPETENCY.

THE INFRASTRUCTURAL FACILITIES AT THE INSTITUTE HAVE BEEN AUGMENTED CONSIDERABLY AND TO FURTHER STRENGTHEN THE RESEARCH ACTIVITIES, THE INSTITUTE HAS INTRODUCED Ph.D. COURSES IN ELECTRONICS AND TELECOMMUNICATION ENGINEERING (EXTC) & COMPUTER ENGINEERING (CMPN).

INFRASTRUCTURE FACILITIES

WE HAVE EXCELLENT INFRASTRUCTURE FACILITIES SUCH AS MULTIMEDIA EQUIPPED CLASSROOMS, STATE-OF-THE-ART LABORATORIES, COMPUTER CENTRE, LEARNING AND INFORMATION RESOURCE CENTRE, ETC.

PG TEACHERS

OUR MAJOR STRENGTH LIES IN A STRONG TEAM OF HIGHLY QUALIFIED PG FACULTY, THE NUMBER OF ME APPROVED TEACHER IN COMPUTER ENGINEERING DEPARTMENT ARE 13 AND IN ELECTRONICS AND TELECOMMUNICATION DEPARTMENT ARE 14.

PG SELECTION PROCESS

AT SFIT, WE FOLLOW THE GUIDELINES OF DTE AND SELECT STUDENTS BASED ON GATE SCORE, CAP ROUND AND B.E. MARKS FOR MINORITY AND INSTITUTE LEVEL SEATS.



M.E. Admission (SANCTIONED INTAKE= 18)

	ACADEMIC YEAR/BATCH	STUDENT ENROLLED	ME DEGREE COMPLETED
COMPUTER ENGINEERING	2012-13 / 12-14	17	100%
	2013-14 / 13-15	18	12% (33 % AWAITING VIVA VOCE)
	2014-15 / 14-16	15	IN PROCESS
	2015-16 / 15-17	10	-

	ACADEMIC YEAR	STUDENT ENROLLED	ME DEGREE COMPLETED
ELECTRONICS & TELECOMMUNICATION ENGINEERING	2012-13 / 12-14	10	100%
	2013-14 / 13-15	16	25%
	2014-15 / 14-16	18	IN PROCESS
	2015-16 / 15-17	11	-

STUDENT INDUCTION PROGRAMME

INSTITUTE CONDUCTS INDUCTION PROGRAMME FOR FRESHERS. THE BASIC PURPOSE OF AN INDUCTION PROGRAM IS THE INTEGRATION OF NEW STUDENTS WITH THE SYSTEMS AND PROCESSES IN THE INSTITUTION. IT ALSO HELPS NEW STUDENTS TO SETTLE DOWN QUICKLY BY FAMILIARIZING THEMSELVES WITH THE NEW ENVIRONMENT OF THE INSTITUTE.

MILESTONES

- a. **100% STUDENT OF FIRST BATCH OF COMP AND EXTC HAVE COMPLETED ME DEGREE**
- b. **60% STUDENT FROM SECOND BATCH HAVE COMPLETED THE DISSERTATION WORK AND ARE IN PROCESS OF SUBMITTING THE THESIS TO MUMBAI UNIVERSITY**
- c. **LOPES RENIA MELVIN WON BEST PAPER AWARD FOR PAPER TITLED "EVALUATION OF MUSIC FEATURES FOR PUK KERNEL BASED GENRE CLASSIFICATION" AT CONFERENCE ICACTA 2015, PUBLISHER ELSEVIER PROCEEDIA COMPUTER SCIENCE**
- d. **ONLY INSTITUTE IN UNIVERSITY OF MUMBAI TO ORGANISE ONE WEEK SHORT TERM COURSE FOR ME STUDENTS ON NEXT GENERATION NETWORK AT CETTM (CENTRE OF EXCELLENCE IN TELECOM AND MANAGEMENT)**



Regular Activities

- **ONE WEEK FACULTY INDUCTION PROGRAMME**
- **STAFF ORIENTATION**
- **INAUGURATION OF M.E. PROGRAMME**
- **DIRECTOR'S TALK**
- **M.E. ORIENTATION**
- **LIBRARY ORIENTATION & INSTRUCTION FOR STUDENTS**
- **TECHNICAL WORKSHOP/S**
- **PROJECT ORIENTATION**

Additional Inputs

- **FOR THE ENHANCEMENT OF CAPABILITIES OF INDIVIDUALS FOR ACTUAL PRACTICE, PROGRAMME OFFERS NON-CREDIT COURSE LIKE PEDAGOGICAL SKILLS DEVELOPMENT, E-LEARNING, ICT RESEARCH METHODOLOGY ETC.**
- **A TWO DAY WORKSHOP WAS CONDUCTED ON NS-2 AND RF AND ANTENNA DESIGN TO GIVE HANDS ON EXPERIENCE TO OUR M.E. STUDENTS**
- **TO MOTIVATE FACULTY, SFIT SPONSORED Ms Anjali Chaudhari , Mr Inderkumar Kochar (ASSISTANT PROFESSOR, EXTC DEPARTMENT) AND Mr CHETAN MISHRA (STUDENT, ME EXTC) FOR A TWO WEEK CERTIFIED COURSE ON "HIGH FREQUENCY STRUCTURE SIMULATOR (HFSS)", A SIMULATOR, WIDELY USED FOR RESEARCH IN MICROWAVES / RF / ELECTROMAGNETICS, HELD AT INTERNATIONAL CENTRE FOR RADIO SCIENCE (ICRS), JODHPUR, RAJASTHAN WHICH WOULD HELP THEM TO DESIGN AND ANALYSE NOVEL ELECTROMAGNETIC STRUCTURES**





ME EXTC



ME CMPN



Supporting Staff



Administrative Staff





LEARNING And INFORMATION LEARNING AND INFORMATION

RESOURCE CENTRE RESOURCE CENTRE



Ms. CHINMAYEE BHANQE (LIBRARIAN)

B.Sc., M.L.I.Sc., M.Phil., SET, NET

LIBRARY TEAM



(L-R: MR. RAHEEM SAYYAD - Lib. ATTENDANT, MS. SUCHETA PRABHUDESAI - ASST. LIBRARIAN, MS. CHINMAYEE BHANQE - LIBRARIAN, SISTER BHAVYA - ASST. LIBRARIAN, MR. ANANT YADAV - Lib. ATTENDANT)



Close to 15 years, our SFIT Central Library popularly known as the Learning and Information Resource Centre has made its members stronger by providing guided access to our vast collection of books - both academic and leisure reading. We are honoured to be involved in the creation of a learning environment while serving almost 250 members on a daily basis.

Over the past years, the library has refocused its priorities to become actively involved and contribute toward expanding its facilities and activities.

Collection re-building has been a major on-going activity as always. The following statistics is indicative of the same:

U.G. Books: 23668

P.G. Books: 1095

Book Bank Books: 1162

CDs: 2928

Project Reports: 1188

Faculty Ph.D. Dissertations: 7

Newspapers (Print): 12

Old Question Papers: available as soft copy too

Activities:

- **2nd Training and Mutual Learning Programme** – Our Library conducted the 2nd Training and Internship for Ms. Purnima Sarkar from SHPT School of Library Science, SNDT University, Churchgate from February 2, 2015 to March 28, 2015. She was given a full 240 hours of hands-on-training for LibSuite Library Software, DSpace Institute Repository, Creating a Bibliography of Project Reprots, Creating and Maintaining a Blog on Wordpress platform, Creating Posters for various occasions. She was also familiarized with the Book Bank and Scholar's Card facility of the library.
- **New Facility gains ground!** –The new application developed by Mr. Shripad Thombre (Lab. Assistant - INFT Department) for capturing and calculating Library Footfalls has helped the students and the library staff alike. Thanks Mr. Shripad!
- **Book Overdue App** – T.E. CMPN students develop an app for the library users. Book Overdue – an app developed by the students of T.E. CMPN – Clyde Mendonca, Vikrant Fernandes, Liston Mascarenhas and Alfred Johnson under the able guidance of Dr. Vikram Shete (Convener – E-Cell) and Ms. Chinmayee Bhanje (Librarian). Using this application, one can keep track of the number of days left to return the books one has borrowed. It also helps to keep track of the number of days the book was overdue and receive quick notifications from the library. The app is available for free download from the Google PlayStore.



CELEBRATION OF "WACHAN PRERANA DIWAS" (READING INSPIRATION DAY) IN THE LIRC

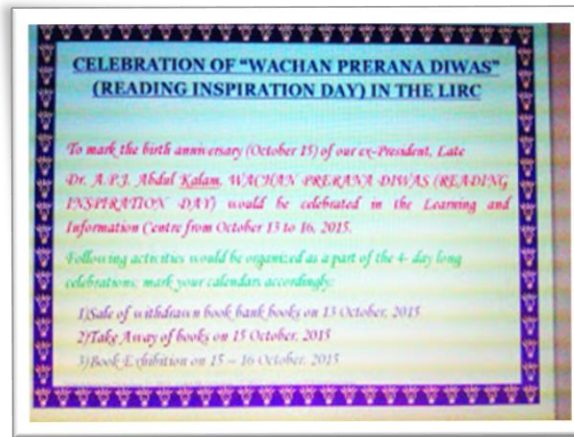

VAACHAN PRERANA DIWAS (Reading Inspiration Day) WAS CELEBRATED IN ST. FRANCIS INSTITUTE OF TECHNOLOGY (BORIVALI, MUMBAI) TO COMMEMORATE THE BIRTH ANNIVERSARY (15 OCTOBER) OF LATE DR. A.P.J. ABDUL KALAM - THE MISSILE MAN OF INDIA.

AS PART OF THE CELEBRATIONS, THE LEARNING AND INFORMATION RESOURCE CENTRE (CENTRAL LIBRARY) INITIATED A FEW ACTIVITIES AS OUTLINED BELOW:

- 1) TAKE AWAY OF BOOKS**
- 2) SALE OF WITHDRAWN BOOKS**
- 3) BOOK EXHIBITION**
- 4) MODIFICATION OF THE OVERDUES**
- 5) EXTENDING SCHOLAR'S CARD FACILITY TO STUDENTS WHOSE GPA IS \geq 8.6.**

THE LIRC WITNESSED A HUGE RESPONSE FOR THE TAKE AWAY OF BOOKS AND THE SALE OF WITHDRAWN BOOK BANK BOOKS. MORE THAN 150 PEOPLE VISITED THE LIBRARY AND AN ODD 100 AVAILED THE SAME. STAFF AND STUDENTS ALIKE WERE HAPPY AND ALL SMILES SINCE ALMOST EVERYBODY GOT SOMETHING TO CARRY WITH THEM.

BOOK EXHIBITION WAS WELL ORGANIZED WITH A MAJORITY OF THE BOOKS ON "WIRELESS COMMUNICATIONS". MANY FACULTY MEMBERS GLANCED THROUGH THE DISPLAYED BOOKS AND A FEW SELECTED THEM TOO.

THE MODIFICATION IN THE OVERDUES STRUCTURE CAME AS A PLEASANT SURPRISE FOR THE STUDENT COMMUNITY AND THEY WERE MORE THAN HAPPY TO TAKE NOTE OF THEIR REDUCED FINES.

FROM THE NEXT SEMESTER ONWARD, SCHOLAR'S CARDS WOULD BE EXTENDED TO STUDENTS WHOSE GPA IS \geq 8.6 THEREBY MAXIMIZING THE LIBRARY'S USAGE.

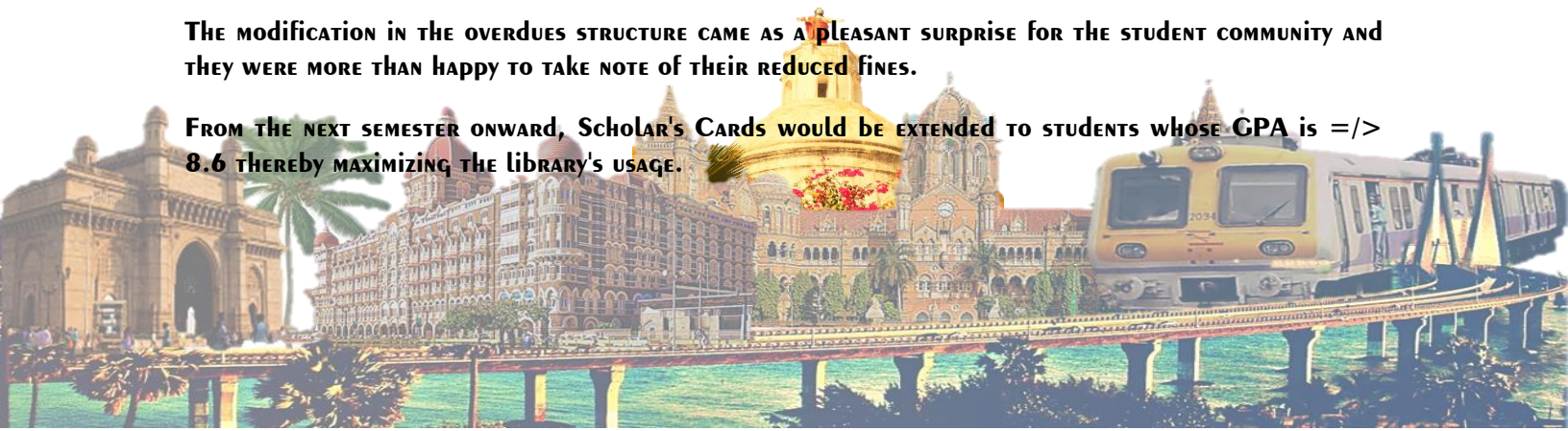

All in all, the library did mark the VAACHAN PRERANA DIWAS by offering a tribute to the vision and knowledge of DR. A.P.J. Abdul Kalam.



ALUMNUS RE-CONNECTS WITH THE LIBRARY



MR. ABHIJEET MAHARANA (ALUMNUS 2006)

THE LIBRARY IS VERY GRATEFUL FOR THE LARGE NUMBER OF BOOK DONATIONS IT RECEIVES FROM STUDENTS – BOTH CURRENT AND EX, ACADEMICS AND THOSE ASSOCIATED WITH THE COLLEGE FROM TIME TO TIME. MANY ALUMNI DECIDE TO DONATE SOME OF THEIR BOOKS TO THE LIBRARY AFTER THEY HAVE FINISHED STUDYING AS A WAY OF SAYING THANK YOU TO THE COLLEGE. THIS HAS HELPED THE LIBRARY TO MAINTAIN ITS COLLECTIONS OVER THE YEARS.

ABHIJEET MAHARANA, OUR ALUMNUS OF CMPN BRANCH IS ONE OF THEM. HE WAS AN AVID LIBRARY USER AND NOW WHENEVER HE COMES DOWN TO MUMBAI, HE MAKES IT A POINT TO VISIT HIS ALMA MATER AND THE LIBRARY. WHEN HE WAS A STUDENT, HE DID DONATE MANY E-BOOKS TO OUR LIBRARY.

THIS TIME TOO, HE HAS DONATED FEW BOOKS TO THE LIBRARY THROUGH AMAZON. WE ARE VERY HAPPY TO RECEIVE THE FOLLOWING FIVE BOOKS IN OUR COLLECTION:

- 1) TURNING POINTS by DR. A.P.J. ABDUL KALAM**
- 2) ELON MUSK: HOW THE BILLIONAIRE CEO OF SPACEX AND TESLA IS SHAPING OUR FUTURE by ASHLEE VANCE**
- 3) WINGS OF FIRE: AN AUTOBIOGRAPHY by DR. A.P.J. ABDUL KALAM**
- 4) BLOCKCHAIN: BLUE PRINT FOR A NEW ECONOMY by MELANIC SWAN**
- 5) MASTERING BITCOIN by ANDREAS ANTONOPULOS**

ABHIJEET IS CURRENTLY IN SEATTLE (WASHINGTON STATE) WORKING WITH AMAZON AS AN SDET ON THEIR MOBILE PLATFORM.



Book Overdue App Developers

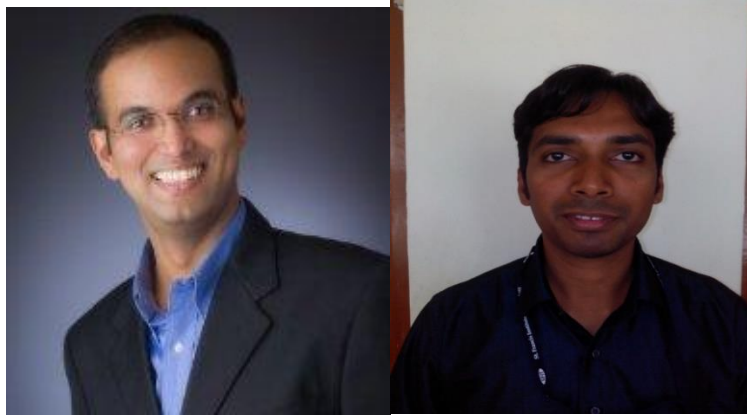

Dr. Vikram Shete, Mr. Johnson Pen, Clyde Mendonca, Liston Mascarenhas, Vikrant Fernandes, Alfred John



SFIT

NSS (NATIONAL SERVICE SCHEME)

AND

SRC (SOCIAL RESPONSIBILITY CELL)



NSS COORDINATOR: PAUL FERNANDEZ(MSW)

In SFIT youngsters are transformed into technological entrepreneurs and innovative leaders. SFIT also aims at making these youngsters into social entrepreneurs and for this purpose SFIT- Social Responsibility Cell (SFIT-SRC) was formed and inaugurated on 22nd March 2015, with the aim to create awareness among our students on social responsibility, ethical values, professional ethics, protection of environment and ecosystems and also to undertake social service activities mainly for the economically backward and marginalized communities.

Until the birth of SFIT SRC the Angels Club shouldered the responsibility of creating awareness among staff and students regarding various social service activities. The SRC has an NSS Unit consisting of 50 dedicated volunteers whose motto is “Not Me But You” who have initiated and implemented the following Social Service Activities within a span of seven months.



Activities Conducted:

- **Training for the Housekeeping Staff of SFIT** on 10th July 2015.
- **Clothes Donation Drive** from 27th July 2015 to August 6, 2015.
- **Book Donation Drive** from 23rd July to 6th August 2015.
- **Visit to Shanthidaan** on 1st August 2015
- **Campus Clean-up Day at SFIT** on 15th August 2015.
- **Health & Hygiene Campaign at Shanti Daan** on 12th September 2015.
- **Beach Clean-Up Drive at Juhu** on 28th September 2015.
- **Blood Donation Campaign** on 29 September 2015.
- **Social Responsibility Cell (SFIT-SRC) logo designing competition** from 10th - 22nd September 2015.
- **Go Green SFIT, A Signature Campaign to reduce the use of plastic bags** from the 16th – 30th September 2015.
- **SFIT NSS Website Launched on 24th September 2015 and linked to SFIT website.**
- **Fire Safety Mock Drill** on 13th January 2016.
- **Medical Check-up Camp for SFIT Staff** on 16th January 2016.
- **Cleanliness drive at Borivali Railway Station** on 26th January 2016.
- **Adoption of Shanti Daan:** Shanthidaan Daan a home for the destitute situated at LT Road, Gorai Creek, Borivli has been adopted by the NSS unit for regular activities.





NSS Volunteers visiting Shatidaan



NSS Volunteers at Juhu beach Clean up



Cleanliness Drive at Borivali Railway Station



Blood Donation Camp at SFIT



Fire Safety Mock Drill



Medical Checkup at SFIT



ISTE STTP

Two –Week ISTE SHORT TERM TRAINING PROGRAMME (STTP) ON TECHNICAL COMMUNICATION



A SHORT TERM TRAINING PROGRAMME ON TECHNICAL COMMUNICATION WAS CONDUCTED BY IIT BOMBAY UNDER THE NATIONAL MISSION ON EDUCATION THROUGH ICT (MHRD Gov. of India) AT SFIT, ONE OF THE REMOTE CENTRES. THE STTP INVOLVED ONLINE QUIZZES, MOODLE ASSIGNMENTS AND INTERACTIVE SESSIONS VIA VIDEO CONFERENCING.

Two –Week ISTE SHORT TERM TRAINING PROGRAMME(STTP) ON ENGINEERING PHYSICS

A TWO WEEK SHORT TERM TRAINING PROGRAMME ON 'ENGINEERING PHYSICS' WAS CONDUCTED BY IIT BOMBAY UNDER THE NATIONAL MISSION ON EDUCATION THROUGH ICT(MHRD Gov. of India)AT SFIT.

THE PROGRAMME WAS CONDUCTED FROM 08/12/2015 TO 18/12/2015 WHICH INCLUDED TOPICS LIKE ELECTROMAGNETISM, QUANTUM MECHANICS, MAGNETISM, OPTICS, SUPERCONDUCTIVITY, SOLID STATE PHYSICS AND CRYSTALLOGRAPHY. EMINENT RESOURCE PERSONS: DR. DIPAN GHOSH, DR. SHIVPRASAD, DR. K. SURESH TAUGHT EACH TOPIC FROM ITS BASIC TO ADVANCE LEVEL. THE SESSIONS ALSO INCLUDED INTERACTIVE TALKS, TUTORIAL, QUIZZES AND ASSIGNMENTS.

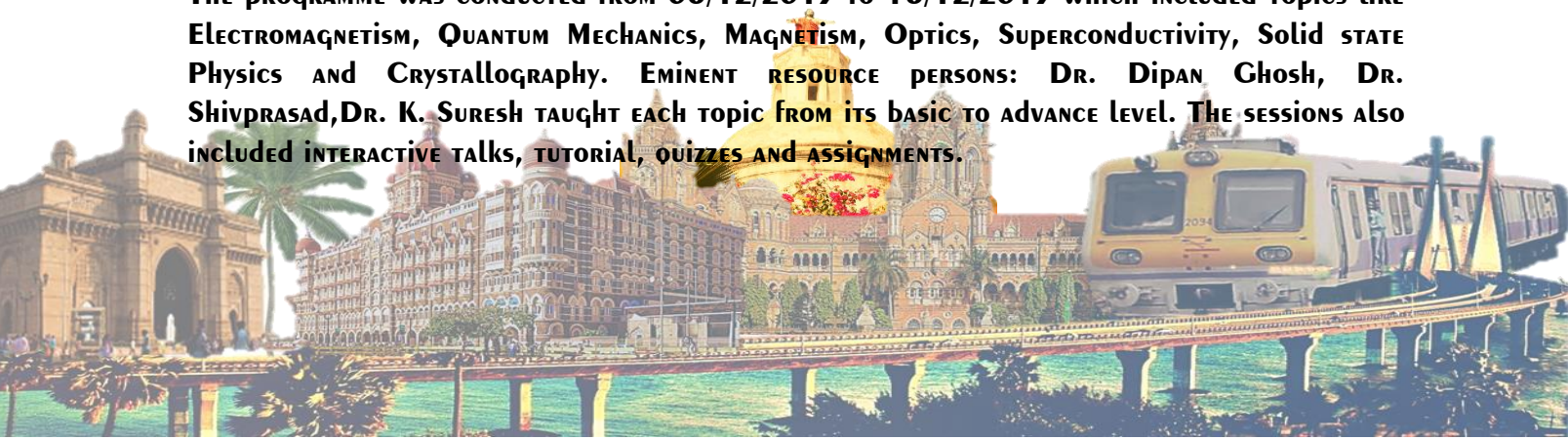



With this wonderful rangoli, the cultural committee added to the auspicious occasion of Diwali wishing all the SFITians in a colourful way.

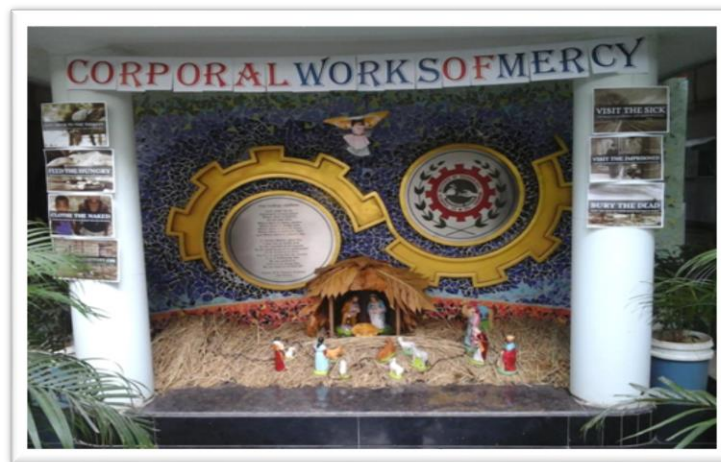

"Joy to the world the Lord has come!

Let Earth receive her King"

To spread the joy and blessings of Christmas with the theme 'Seven Corporal Works of Mercy' in mind, the cultural committee created the Christmas crib at our college. Merry Christmas!



New Dimensions

FACULTY COORDINATOR: Ms DEEPA PANAKKAL



STUDENT COORDINATOR: DANIEL D'SOUZA



THE CULTURAL CLUB HAS BEEN ACTIVELY PARTICIPATING AND CONTRIBUTING TO THE CULTURAL ZEAL OF SFIT. THE INDEPENDENCE DAY WAS CELEBRATED WITH AN IMPORTANT THEME, A MESSAGE IN MIND, 'VICTIM BLAMING'. WITH PRESENTATIONS, PERFORMANCES AND A PLAY, THE MESSAGE WAS PUT ACROSS IMPACTFULLY BY OUR STUDENTS. A TRIBUTE WAS PAID TO LATE DR. A. P. J. ABDUL KALAM THROUGH A WONDERFUL PRESENTATION.





IN THE MONTHS OF SEPTEMBER AND OCTOBER, NEW DIMENSIONS HELD AUDITIONS FOR THE COLLEGE CONTINGENT FOR EVERY CONCEIVABLE CULTURAL CATEGORY, BROADLY DIVIDED INTO LITERARY ARTS, CREATIVE ARTS, AND PERFORMING ARTS.

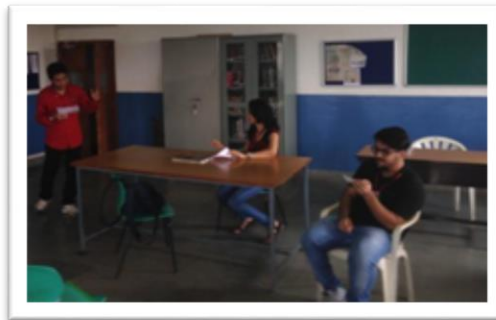

THESE AUDITIONS WITNESSED A HUGE TURNOUT OF ENTHUSIASTIC STUDENTS WHO EXPRESSED DELIGHT AT THE COLLEGE NOT ONLY ENCOURAGING PARTICIPATION IN CULTURAL ACTIVITIES, BUT ALSO POTENTIALLY HOSTING INTER-COLLEGIATE COMPETITIONS ITSELF, IN THE NEAR FUTURE.

OUR STUDENTS FROM NEW DIMENSIONS REPRESENTED SFIT IN VARIOUS COMPETITIONS AND WERE APPRECIATED AND AWARDED FOR THEIR PARTICIPATION AND PERFORMANCE.



TRAINING & PLACEMENT CELL



MR.MRINMOY CHAUDHARY

TRAINING & PLACEMENT OFFICER



MR.VIDYA REDIJ

ASST. TRAINING & PLACEMENT OFFICER

*

TRAINING:

THE INSTITUTE TRAINING & PLACEMENT CELL IS AN ACTIVE DEPT. COMPRISED OF COMPETENT PROFESSIONALS. DEPT. HAS ESTABLISHED FULL PROOF SYSTEMS TO COUNCELL & IDENTIFY STUDENTS ASPIRATIONS & FOCUS.

OUR SYSTEMS PROVIDE ON GOING OPPORTUNITY TO STUDENTS TO UNDERGO EXTENSIVE TRAINING, EMPLOYABILITY SKILLS TESTS, INDUSTRY EXPERTS BRIEFING, SOFT SKILLS TRAINING, BASIC TECHNICAL PRACTICES, APTITUDE TESTS, ETC. ON REGULAR BASIS & CONTINUED PRACTICAL'S SESSIONS BY INSTITUTE FACULTIES TO OUR STUDENTS AS PER SET TRAINING CALENDARS EVERY SEMES

WE INVITE TOP TECHNICAL EXPERTS FROM REPUTED LEADER INDUSTRIES, PROFESSIONALS AND BUSINESS ENTREPRENEURS TO TRANSFORM STUDENTS TO LIVE & CURRENT EXPOSURE AND CAREER GUIDANCE TO OUR STUDENTS.

WE ARE AVAILING CONTINUOUS SUPPORT FROM REPUTED INDUSTRIES AND COMPANIES TO MOULD & TRAIN CORE ENGG TO BOOST THE CAREER OF YOUNG ENGINEERS & BECOME MOST SUCCESSFUL ENGINEER OF INDUSTRIES.



THE TRAINING AND PLACEMENT DEPARTMENT MOTIVATES THE STUDENTS PROVIDING THE NECESSARY ROAD MAP, COUNSELING AND GUIDANCE FOR THEIR JOB POTENTIAL, PERSONALITY DEVELOPMENT & STUDENTS ARE BRIEFED ABOUT CORPORATE SECTORS/ INDUSTRY PRACTICES.

OUR STUDENT'S PLACEMENT RECORDS & ACHIEVEMENTS DURING LAST 5 YEARS

PLACEMENT STATISTICS



TRAINING & PLACEMENT COMMITTEE



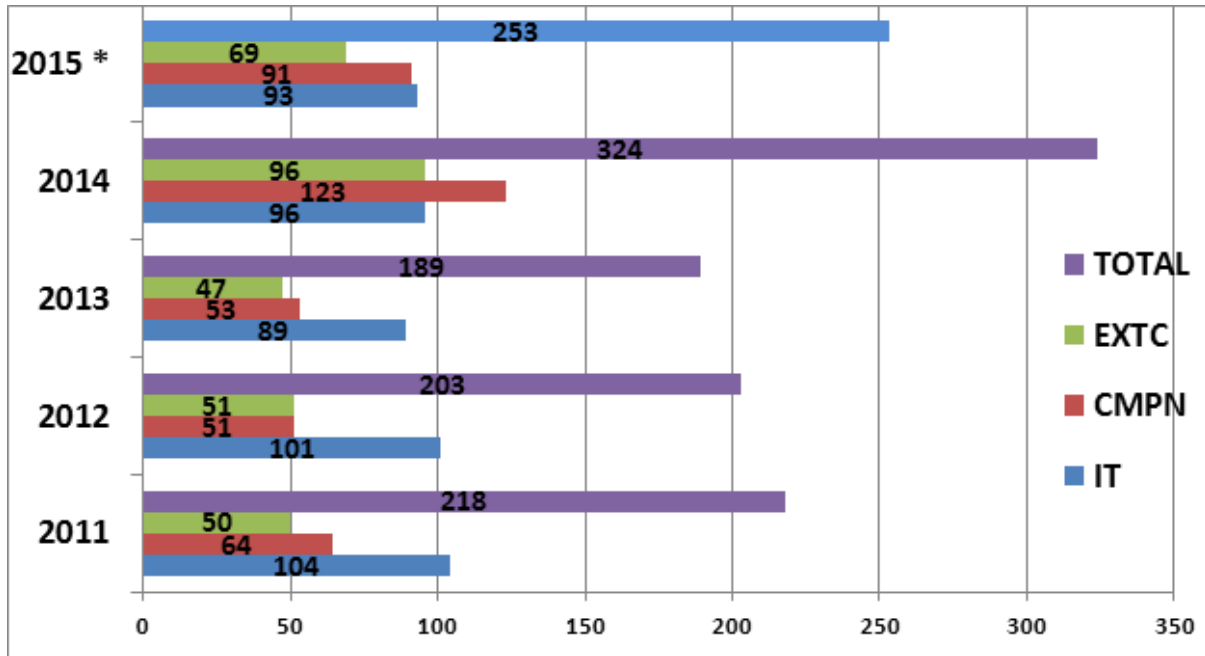

85%-90% of students are recruited by many reputed industries by companies like TCS, INFOSYS, Cap Gemini, L&T INFOTECH, TECH-MAHINDRA, ACCENTURE, PERSISTANT, GODREJ-INFOTECH, HEXAWARE, ATOS ORIGIN, MAQ, IQATE, INGRAM MICRO, NEEBAL TECHNOLOGIES, QUINNOX, MU SIGMA, MINDKRAFT & MANY MORE.

MORE THAN 45 NOS INDUSTRIES HAVE VISITED OUR INSTITUTE & CAMPUS RECRUITMENTS FOR 2014-15 ACHIEVED 95% PLACEMENT.



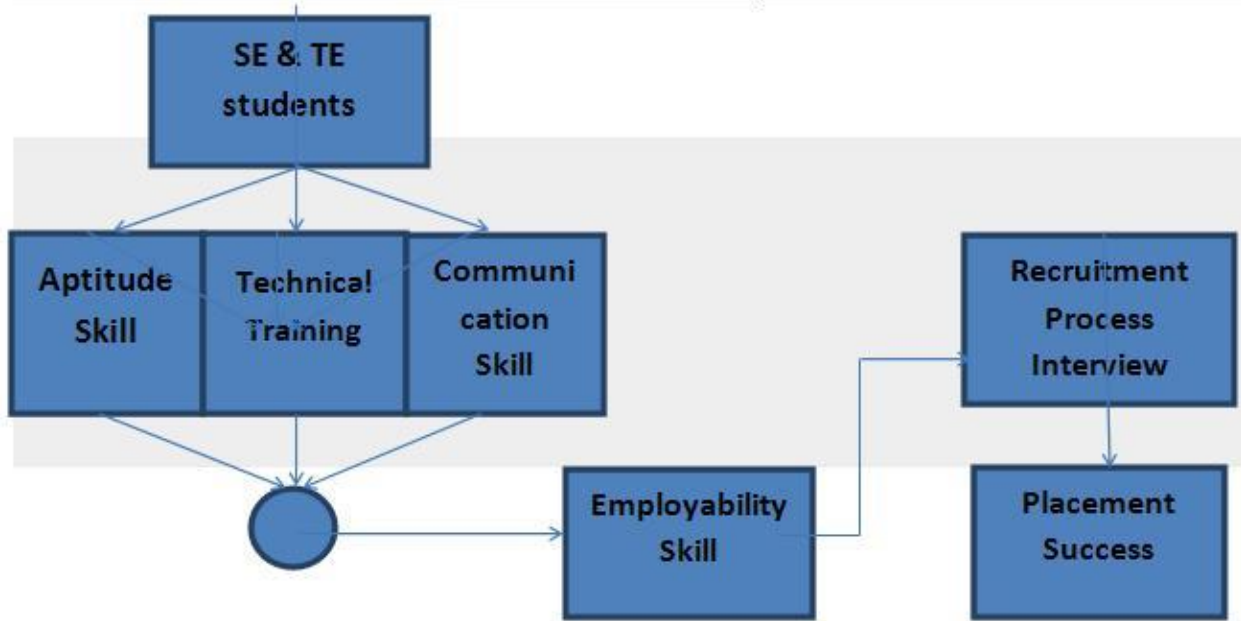

MRINMOY CHAUDHURY
(HEAD TRAINING & PLACEMENT)



TOPPERS SE INFT [SEM IV]



Prachi Kate
9.11 SGPA



Prachi Mishra
8.96 SGPA



Mitali Ghotgalkar
8.71 SGPA

TOPPERS SE CMPN [SEM IV]



Sweenal Furtado
9.86 SGPA



Elza Asha
9.29 SGPA



Aakash Dhongade
9.21 SGPA



TOPPERS SE EXTC [SEM IV]



Rhea D'Souza
9.57 SGPA



Natasha D'Souza
9.5 SGPA



Aradhana Kaintura
9.43 SGPA

TOPPERS FE [SEM III]



NEHA NAIK
10 SGPA



D SOUZA
9.78 SGPA



RAVEENA DCOSTA
9.78 SGPA

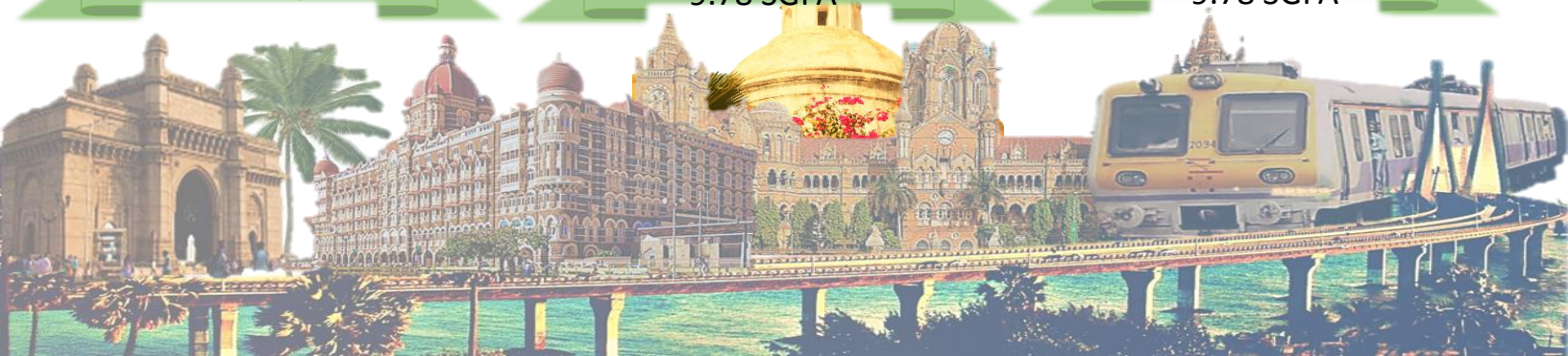

TOPPERS TE INFT [SEM VI]



SEAN MIRANDA
9.2 SGPA



ADARSH ASHOK
9.08 SGPA



AKASH GHAGARE
9.04 SGPA



SAMIKSHA SALGAONKAR
9.04 SGPA



TOPPERS TE CMPN [SEM VI]



POOJA PANDIT
10 SGPA



RISHABH TIWARI
9.83 SGPA



PEREIRA LARISSA
9.67 SGPA

TOPPERS TE EXTC [SEM VI]



CREADO STEFFI
8.29 SGPA



NEHA NAYAL
8.04 SGPA



NADAR MELWIN
7.89 SGPA



TOPPERS BE CMPN [SEM VIII]



Linus Castelino
76.33



Rhea Alexander
79.13



Veer Lade
76.47



Clyton Dantis
76.33

TOPPERS BE EXTC [SEM VIII]



Pratik Jhunjhunwala
75.16



Sonia Fernandes
74.71



Rini Lobo
75.03



Joanna P
75



Brinetta Dmello
74.71

TOPPERS BE INFT [SEM VIII]



Madan Panth
77.47



Valentina Rodrigues
75.03



Abhay Khandhar
76.87

TOPPERS ME CMPN



RAMYA ELIZABETH
9.27 SGPA



ANDRAT HYCINTA
9.09 SGPA



Colaco Janisa
9.02 SGPA

TOPPERS ME EXTC



SAPTARSHI JULY
8.23



PEREIERA SWETTA
8.18



VIDEO SUMMARIZATION USING CLUSTERING

[CMPN]

By

Late. Gaurav Dudwadkar
Srinidhi Srinivasa Raghavan
Aditya Hegde

Under the guidance of
Dr. Kavita Sonawane

The sublime raise in the digital multimedia technology has resulted in a colossal amount of typical unstructured videos. So as to ensure a time efficient way of processing this gamut of lingering videos, video summarization abridges the original unedited video and generates a shorter video free of redundancy and irrelevant details. In this work, we use three different clustering techniques to summarize a video and also evaluate their performance, for six disparate video categories, based on parameters like accuracy, processing time and output video length. Specifically, the temporal video segments- represented as motion vectors- are clustered using K-Means, Kekre's Proportionate Error Algorithm and Fuzzy C-Means and then significant segments chosen from these clusters are played to construct the resultant video. The pros and cons of these three clustering techniques are weighed upon carefully and future optimizations are also suggested.

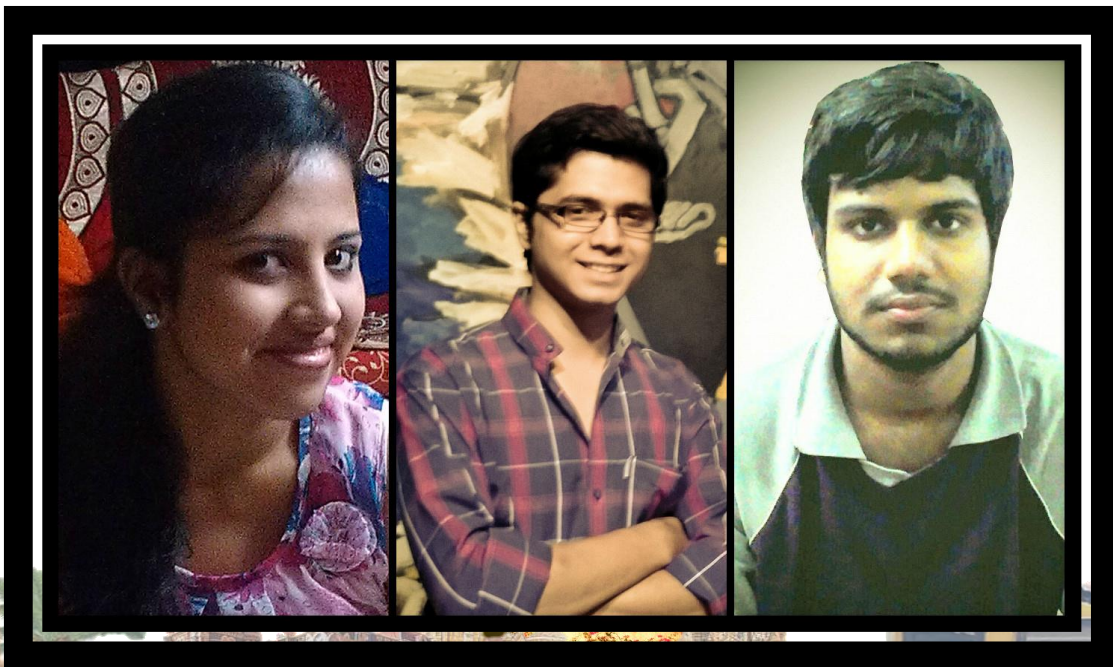

REFRESHABLE BRAILLE DISPLAY FOR THE VISUALLY IMPAIRED [CMPN]

Ajay Thorve, Raveendra Tudangil, Roger Correia

Advisor:
Dr. Vikram V. Shete

ABSTRACT

Refreshable braille displays are dynamic readers for the visually impaired people. While braille books are a good means to archive information, refreshable displays will allow the user to access more information in a smaller form factor.

Currently employed Braille displays are typically priced in the range of USD 2500-4000 (USD 65-100 per Braille character) and are thus inaccessible to users in both developed and developing countries. Development of affordable Braille displays is thus a critical need.

In this project we developed an affordable refreshable braille display. This display is a portable display which when given an audio input in English, will display the contents the user desires to read in Braille Script. In this work we present an extremely low cost prototype of a single character refreshable braille display. We also demonstrate the use speech recognition for a fast paced self-learning experience.

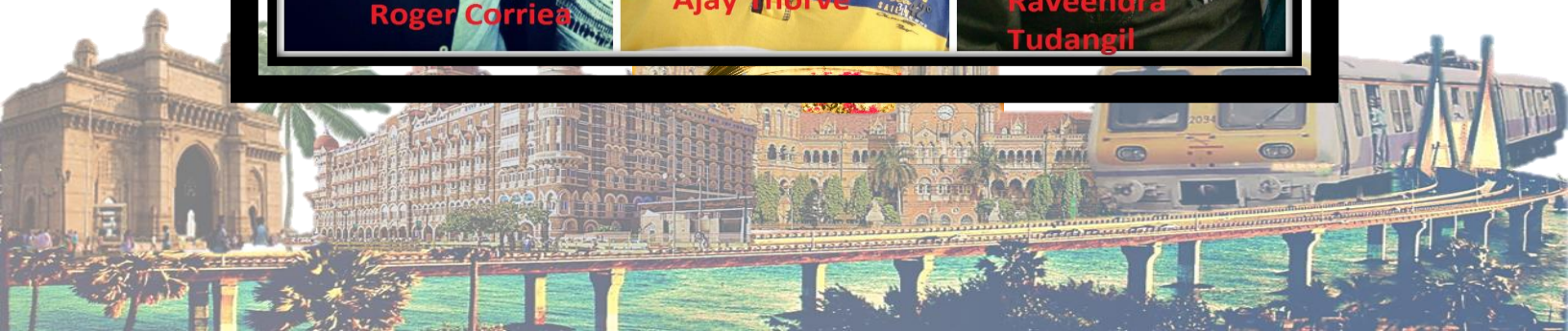

Chaos Based Image Encryption

[EXTC]

ABSTRACT

In recent years, owing to frequent flow of digital images across the world over the transmission media, it has become essential to secure them from leakages. Due to the exceptionally desirable properties of mixing, sensitivity to initial conditions and parameters of chaotic maps; chaos-based encryption has recommended a new and efficient way to deal with the problem of fast and highly secure image encryption. The implemented image encryption scheme consists of an 80-bit secret key and uses chaotic map like Arnold Cat-Map and Logistic Map. The initial conditions for the chaotic maps are derived using the 80-bit secret key. In this cryptosystem, permutation-diffusion architecture followed by an efficient diffusion scheme is implemented. This scheme consists of two diffusion procedures, with a supplementary diffusion procedure padded after the normal diffusion. In the supplementary diffusion module, the control parameter of the selected chaotic map is altered by the resultant image produced after the normal diffusion operation. As a result, a slight difference in the plain image can be transferred to the chaotic iteration and bring about distinct key streams, and hence totally different cipher images will be produced. Therefore, this scheme can remarkably accelerate the diffusion effect of the cryptosystem and effectively resist differential attacks. Our project objective is to provide high level of security and satisfactory encryption speed for practical secure image applications.



Complex Impedance Transformers [EXTC]

ABSTRACT

Complex impedance transformers can be used to solve the conventional problem of imaginary value of characteristic impedance of transmission-line sections. The complex impedance transformers consist of only transmission-line sections, and the design formulas are the function of the reflection coefficients of the complex termination impedances. Firstly, the impedance transformers that transform a complex impedance into a real one are discussed. Secondly, those transforming a complex impedance to another complex one are studied. Depending on where the complex impedances are located on the Smith Chart, a method to reduce the size is discussed in more detail. We have fabricated and tested a few complex impedance transformers, which have been simulated. The results obtained are in close agreement with those reported in the literature.



Adaptive and Fast Predictions by Minimal Itemsets Creation

[INFT]

Ms. Sonali Vaidya*, Mr. Struan Souto**, Mr. Keegan Pereira**, Mr. Vincent Soares**, Mr. Neil Rego** *,** (Department of Information Technology, Mumbai University, St. Francis Institute of Technology, Mumbai)

ABSTRACT

Association rules in data mining are useful for the analysis and prediction of an individual user's behavior which facilitates the data analysis on a regular basis for market basket data, clustering of products, designing catalogs and playing an immense role for store layout setting. This paper presents a successor of the Apriori and variation of the CHARM algorithm, which is the MG-CHARM algorithm that is used for finding relationships between certain attributes instead of the whole dataset. The MG-CHARM algorithm is an Association Rule Mining (ARM) algorithm that is used to select the target database which in turn takes less time to find the desired association rules. In the proposed implementation, the actions performed by a user will be effectively recorded in the target database. The datasets that are generated will have to be fed to the semi - automated, adaptive software which will fetch the output based on ARM algorithm. The algorithm will determine the relations for different datasets by mining Minimal Generators (mGs) from Frequently Closed Itemsets (FCI's) to carry out decision making and pattern analysis of the Itemsets.

Keywords–Apriori, CHARM, MG-CHARM, ARM, mG's, FCI's.



Struan Souto Vincent Soares Keegan Pereira Neil Rego

Dynamically Heuristic Anti-Fraudulence

[INFT]

PROJECT AREA: Web Application for Network Security

ABSTRACT:

“An ounce of prevention is worth a pound of cure”

- *Colin Powell*

Together with the growth of e-commerce transaction, Phishing the act of stealing personal information - rises in quantity and quality. Phishing is a significant problem involving fraudulent email and web sites that trick unsuspecting users into revealing private information. Phishing is an arms race, with criminals continually devising new ways of tricking people. We present a novel, approach for detecting phishing web sites, based on the **TF-IDF** information retrieval algorithm along with the evaluation of several **heuristics** developed to reduce false positives. Specifically, the proposed method focuses on the similarity of phishing site's URL and legitimate site's URL. In addition, the ranking of site is also considered as an important factor to decide whether the site is a phishing site.

In this proposed system, we present a solution to address the shortcomings

- ❖ Reduce/prevent financial loss from phishing attacks.
- ❖ User can easily find out phishing attacks.
- ❖ System will add one more security layer into online transaction.
- ❖ User can get real bank or any commercial site information.



A REPORT ON PRAYAS 2015

PRAYAS 2015 was a science and technology exhibition which was organized by the Basic Sciences and Humanities Department of St. Francis Institute of Technology, Borivli, Mumbai on the 4th of March 2015 in the assembly hall of the engineering college. It was a one day exhibition from 1.00 pm to 5.00 pm. The word 'PRAYAS' itself explains that it was an attempt by the first year students of SFIT to apply their knowledge of their semester 1 and semester 2 subjects to a working model, so that they get a practical exposure to engineering. The event was coordinated by Mr. Ajay Vishwakarma and Organized by Mr. Utkal Jadhav. The responsibilities were distributed to an organizing committee which included 5 staff members and 8 students from the first year itself. Further, on the day of the exhibition, a discipline committee of 4 members was appointed to maintain the decorum and discipline of the exhibition in the assembly hall. Collectively, 16 projects were prepared by the students. Each project group had a maximum limit of 5 students. Each group was allotted with a guide for technical as well as overall advice. The students were asked to prepare a project report for their work for which they were advised to follow a format. A budget of 5000 INR was approved for the event from college management. A seminar on programming of arduinometer was conducted for the students to help those project groups which needed to work on an Arduino-kit. A seminar on how to present yourself to explain your project was conducted to help students with their body-language, project report and communication skills. A feedback form was designed for the visitors to gain access to their input related to the exhibition and their suggestions for further improvement for the next event. In addition, a different format of a feedback form was given to the project groups to get feedbacks of their visitors.

Event Coordinator

Mr. Ajay Vishwakarma

Event Organizer

Mr. Utkal Jadhav



PRAYAS ORGANIZING TEAM

Organizing Committee (Students)

- Swapnil Samant
- Durvakshi Nare
- Ekta Singh
- Kushal Dedhia
- Nishant Kale
- Aayush Misra
- Stefen Rosario
- Salomie Pereira

Organizing Committee (Teachers)

- Ms. Arti Bhatnagar
- Ms. Sonia A Kumar
- Ms. Ambika Sharma
- Ms. Rujata Saraf
- Ms. Pradnya Pradhan

Discipline Committee (Teachers)

- Ms. Preethi Colaco
- Mr. Sadique Shaikh
- Mr. Ashok Sapkale
- Ms. Madhvi Salokhe

Agenda for the Event

- College prayer.
- Saraswati Vandana along with lamp lighting.
- Brief speech by FE Coordinator.
- Brief by Prayas Coordinator.
- Ribbon cutting.



Robocon 2015 –REPORT

SFIT ROBOCON is proud to present an annual report of ROBOCON 2015. The SFIT ROBOCON team participated in the National Robotics competitions ABU-ROBOCON 2015, held in Balewadi sports complex at Pune from 5th of March to 7th of March 2015. The theme for Robocon 2015 was “**ROBOMINTON**”.

85 teams participated this year. This was the 8th year of SFIT’s participation in this prestigious competition being one of the ten colleges from Mumbai and the team showed their finest performance by beating MIT Pune in the League match.

A team of 21 members, worked hard for eight months with a single objective in mind, to win the competition and one can imagine the kind of emotional turbulence one undergoes every time the memories are brought back. The infinite learning experience both on the technical and the managerial aspect, the art of negotiation with the different people they met in the way to get their work done and the practice of working in a team and realizing the goal together as a team rather than an individual were some of the priceless things that they extracted through this competition their path, too was full of hurdles, at times situations aroused when the whole plan crashed as their strategies failed and they were forced to start from ground zero . But it was during these times that the team members took charge of their responsibilities themselves and the enthusiasm of the team was unparalleled. These moments were inspirational and were also the reason that the ship of our team propelled and survived even the worst conditions. Though the result of the competition did not land in their favor and this has been happening over the past few years, does not mean that their preparation in any field lacked. Despite of all this, the morale of the team is not down. They went there, learned a lot of the new things from other teams, both technical and organizational, and will try to remove all the ills that they faced this year by proper management of time.

The problem statement (Rule book and theme) was released in mid-august 2014. The primary. Task on our agenda was discussing the design of their robots. The team was divided into two groups (service and return).Each team was expected to brainstorm all possible ideas and come up with designs which were approved by both the groups. The seniors were intent on giving equal time and emphasis to both the robots, something which they felt had been missed out last year.

Very few aspects of their robots were inspired by their previous year’s Robots. This has been a year of major technical improvements. The branch wise list of improvements is as follows:

Mechanical:

1. Support Shaft system and Omni wheels were introduced for the first time. These mechanisms and components highly improved stability of the robots, provided better locomotion control and reduced the load on motors.
2. Another feather in the cap was the use of pneumatic rotatory actuator and ball bearing mountings as SFIT Robocon team was the only team to implement it in the competition.

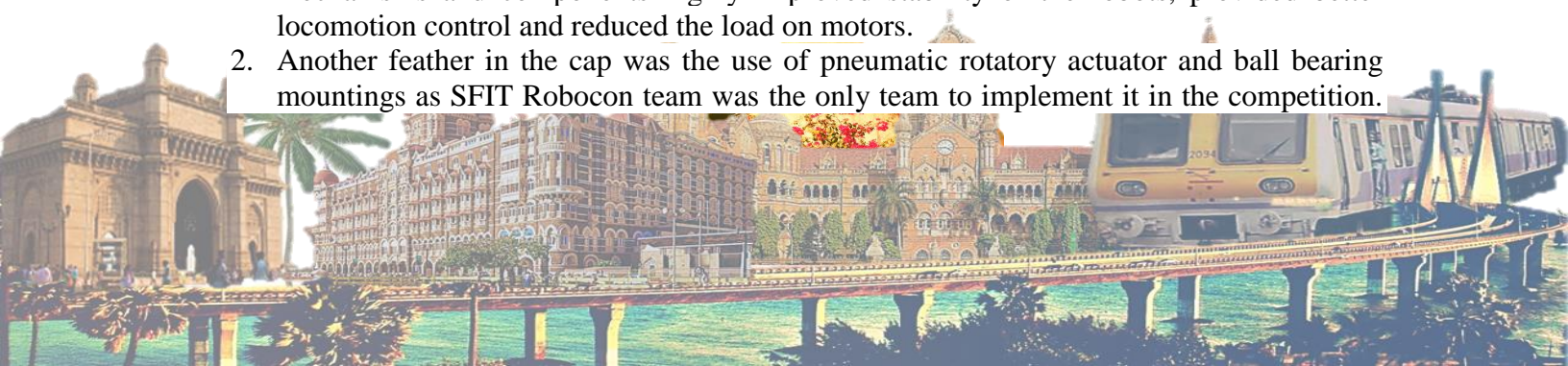

The use of ball bearing mounting greatly eased the working of various mechanisms used in the robots.

3. A spectrum of pneumatic pistons were used and the robots comprised of full Aluminium structure.
4. Aluminium welding (brazing) was attempted for the first time.
5. A considerable amount of market research for a variety mechanical components was done at Nagdevi Estate (Marine Lines, Mumbai).

Electronics:

1. The inefficient Lead Acid batteries were upgraded with high power Lithium Polymer(LiPo) batteries.
2. Hercules Motor Drivers sustaining continuous current of 20Amperes were introduced in order to tackle the major issues faced in the previous year.
3. All in one circuit board (Proto-board) was implemented for the first time. This change in the circuit organization minimized the wires, possibility of errors and debugging time.
4. A completely opto-isolated circuit was implemented.

Coding:

1. The PS2 joystick and Bluetooth Module HC-05 interface with Arduino Mega board was implemented and used for the first time. The use of Bluetooth was mandatory as per the theme rules.
2. Image Processing for tracking the path of shuttlecock was attempted using Open CV and Python.

The team faced problems during practice sessions, due to excessive torque on the racket handle. This was a very disappointing moment, but they didn't lose their hope and tackled the issue wisely. Then resolved the problem by adding a different bolt into it.

Nevertheless, they managed to build one of the most Economical Robots in the competition. Knowing what the obstacles the team had to face towards the end, the members were satisfied by the way we performed and aim towards having a much more successful run in Robocon 2016. Participating in Robocon 2015 was an immense learning experience for all of them. Their experience can be broadly divided into 2 categories, The First being Technical and the other being Management and Ethics.

By far, the most important realization for the team was “learning what to learn” and “knowing where to improve”. In unanimous decision, the team decided to spend the remaining time academics year in sharing technical experiences, helping the juniors in improving the relevant technical skills and discussing the possible technologies that can be implemented this year.

The SFIT ROBOCON team 2015 thanks everyone for the immense support shown towards the team. It was also really wonderful to receive such encouraging support from the seniors and alumni of the SFIT ROBOCON family. The support from the SFIT was great, with ROBOCON Instructor Mr. Vaqar Ansari and Staff Coordinator Mr. Pramod Shanbhag being very much

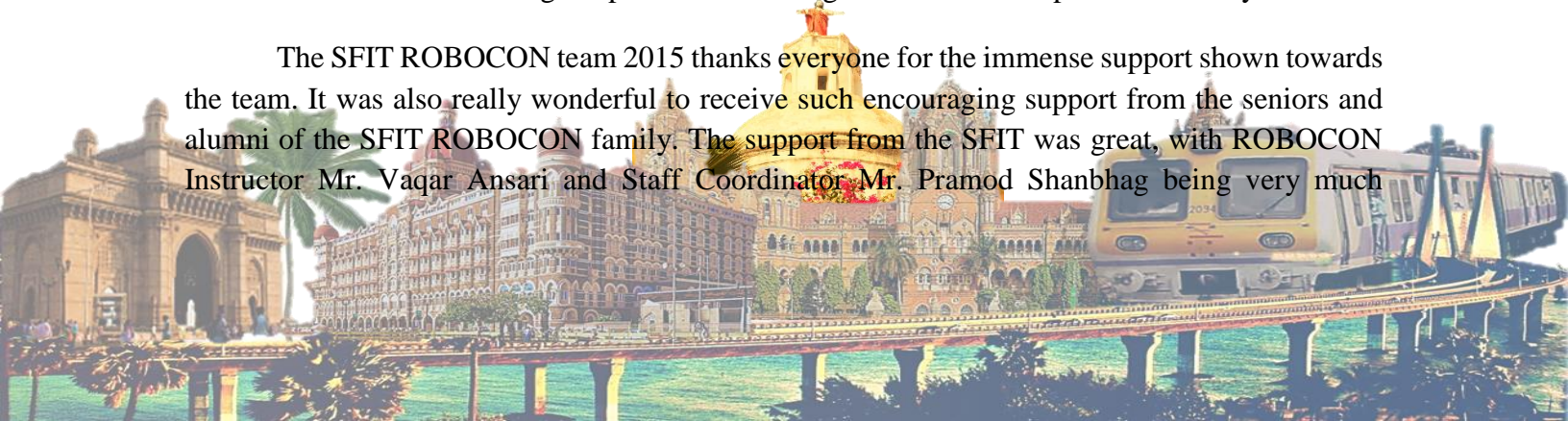

involved in the overall process. The team thanks Bro. K. S. Jose, Deputy Director SFIT for support from the Management department. The SFIT ROBOCON team takes this opportunity to specially thank Bro. Tom Melchior, Director SFIT for his insight, motivation and moral support throughout the year.

Prepared By:

Siddesh G. [TE EXTC]
(CRC Robocon)

Mr. Ansari Vaqar
(SFIT Robocon-Instructor)



E-cell ANNUAL REPORT

1) E-cell Day

NEN
Title Partner:
CODEGURUKUL
www.codegurukul.com

E-CELL
SFIT
Presents

Associate Partner:
State Bank of India
THE BANKER TO EVERY INDIAN

Entrepreneurship Day

9 a.m. to 12 p.m. - Workshop by Mr. Gaurav Karkhanis & Dr. Vikram Shete for FE1, FE3 & FE5
12 p.m. to 1 p.m. - Lunch Break
1 p.m. to 1:30 p.m. - Seminar by Mr. Suneet Sebastian, Founder of Sebastian Fitness Solutions
1:30 p.m. to 2:00 p.m. - Seminar by Mr. Sachin Dedhia, Founder of Skynet Secure
2:00 p.m. to 2:30 p.m. - Seminar by Founders of Stylege and Review by achievers at Prayas
2:30 p.m. to 3 p.m. - Seminar by Dr. Prasad Teegalapelly, Advisor CFSE, NITIE
3:00 p.m. to 3:15 p.m. - Tea Break
3:15 p.m. to 4 p.m. - Workshop by Mr. Gaurav Karkhanis & Dr. Vikram Shete for FE2, FE4 & FE6

Reporting Time:
FE1, FE3, FE4 - 9:00 a.m.
FE2, FE5, FE6 - 12.45 p.m.
Date : 7th March, 2015
Attendance is mandatory for all FEs.

REAL
ENTREPRENEURS

THE ENTREPRENEURSHIP DAY IS THE FLAGSHIP EVENT OF THE SFIT E-CELL, AND IS A DAYLONG EVENT WHICH COMPRISED OF SEVERAL EMINENT SPEAKERS DELIVERING EXCELLENT ORATIONS, AS WELL AS A FUN-FILLED WORKSHOP WITH SEVERAL ILLUMINATING ACTIVITIES. IT WAS HELD ON 7TH MARCH 2015. THIS EVENT HAD AN ATTENDANCE OF ABOUT 300 STUDENTS. THE OBJECTIVE OF THIS EVENT IS TO INTRODUCE STUDENTS OF THE FIRST YEAR TO THE IDEA OF ENTREPRENEURSHIP AND SHOWING THE VIABILITY OF THE SAME AS A SERIOUS CAREER PATH.

THE WORKSHOP, CONDUCTED BY MR. GAURAV KARKHANIS, WAS FILLED WITH MANY ACTIVITIES. THE ACTIVITIES PROVED TO BOTH FUN AND ENTERTAINING WHILE HELPING THE STUDENTS LEARN VARIOUS IMPORTANT LESSONS THAT MR. KARKHANIS HAD THOUGHTFULLY LINKED TO EACH ACTIVITY. THEY LEARNT ABOUT TEAMWORK, MAKING THE BEST USE OF AVAILABLE RESOURCES, OUT-OF-THE-BOX THINKING AND SO MANY MORE LESSONS THAT WILL PROVE TO BE INVALUABLE IN THE FUTURE.

SEMINAR:

MR. SUNEET SEBASTIAN: MR. SEBASTIAN WAS THE FIRST SPEAKER OF THIS SESSION. HE SPOKE ABOUT HIS EXPERIENCE OF DISCOVERING HIS PASSION FOR FITNESS AND HOW HE MANAGED THE COMPLETE SHIFT FROM HIS CAREER AS AN IT PROFESSIONAL TO STARTING HIS OWN FITNESS COMPANY.

MR. SACHIN DEDHIA: MR. DEDHIA WAS THE SECOND SPEAKER OF THE SEMINAR. HE SPOKE ABOUT HIS CAREER AS A CYBER CRIME INVESTIGATOR AND A SECURITY EXPERT FOR



ORGANIZATIONS BOTH IN THE PRIVATE SECTOR AND THE PUBLIC SECTOR. HE SPOKE ABOUT HOW BEING AN ENTREPRENEUR GIVES YOU THE FREEDOM TO DO WHAT YOU ARE PASSIONATE ABOUT. HE PROVED TO BE TRULY INSPIRATIONAL.

AJAY SIR/UTKAL SIR: A FEW PROFESSORS FROM OUR FE DEPARTMENT PRESENTED A REPORT ON 'PRAYAAS', A COMPETITION THAT WAS HELD FOR THE FE STUDENTS ONLY A FEW DAYS BEFORE E-CELL DAY. THEY SPOKE OF THE ACHIEVEMENTS OF THE ORGANISING COMMITTEE THAT COMPRISED OF MANY FE STUDENTS. THEY SHOWED THE STUDENTS HOW MUCH THEY CAN ACHIEVE IF THEY WORKED TOGETHER AS A TEAM.

MR. AAQYL CHAQLA/ MS. NAOMI LEON: MS. LEON AND MR. CHAQLA, BOTH BE STUDENTS FROM OUR COLLEGE, SPOKE ABOUT THEIR EXPERIENCE STARTING THEIR OWN VENTURE, 'STYLEDGE'. THIS WAS VERY HELPFUL, AS IT GAVE THE STUDENTS AN OPPORTUNITY TO SEE THE PROCESS OF HOW A COMPANY GETS ESTABLISHED. THEY SHOWED THEM, VIA A POWERPOINT PRESENTATION, THE VARIOUS STEPS THEY HAVE TAKEN TO IMPROVE THEIR COMPANY AND HOW THEY ARE LEARNING MORE AS THEIR COMPANY GROWS.

DR. PRASAD TEEGALAPELLY: DR. TEEGALAPELLY, THE LAST SPEAKER OF THIS SESSION, SPOKE OF SOME OF THE STUDENT VENTURES HE HAS HELPED. HE SHOWED OUR FE STUDENTS A SOLAR POWERED LAMP THAT WAS PART OF ONE OF THESE VENTURES. HE HAD AN INTERESTING Q&A SESSION WITH THE STUDENTS WHICH TURNED OUT TO BE A GREAT END TO OUR SEMINAR SESSION.



2) SEED PROGRAM



WHO WANTS TO BE AN ENTREPRENEUR

#SEED Program

Student Employability & Entrepreneurship Development
 ...outcome-based learning that uses the new venture creation process as a method to develop entrepreneurial competencies in participants

PROGRAM OVERVIEW

GET SMAC-ED
Creativity & Innovation

#GOTB Get Outside The Building

ADS That Sing

It's All About Money

Design Thinking

#SEED

Find us on Facebook

TOLSEED **TOL.EDUTAINMENT** **E-CELL SFIT**

Program Registration Start Date: 28th July 15
 Program Start Date: 19th Aug. 15
 Venue: St. Francis I.O.T. , Mumbai
 Program Duration: spread over 7 weeks (20 hrs Foundations/Contact + 20 hrs Field work)
 Program Fees: INR 2000- INR 500 for SFIT students
 (discounted price as a part of Alumni Give Back Initiative by Organizer)

IT WAS A MONTH-LONG PROGRAM FOR SE, TE, BE STUDENTS WHEREIN SEVEN SESSIONS WERE CONDUCTED. THIS EVENT TOUCHED UPON VARIOUS ENTREPRENEURIAL TOPICS GROUPED UNDER FOUNDATION, FINANCE, CREATIVITY, SALES AND MARKETING. IT INCLUDED A WIDE RANGE OF TOPICS SUCH AS COMMUNICATION SKILLS, DESIGN THINKING, TARGET DRIVEN SALES, BRANDING BASICS, TEAM SKILLS, REVENUE / PROFIT, BUSINESS MODEL GENERATION, IDEATION, MARKET UNDERSTANDING, FILTERING, BRANDING, CRM AND IDEA FINALIZATION SKILLS. IT CONSISTED OF LECTURES AS WELL AS ACTIVITIES AND ASSIGNMENTS.

MR. GAURAV KARKHANIS WAS THE RESOURCE PERSON FOR THIS EVENT.



3) **STARTUP SATURDAY**

Date & Time:
19th September 2015
10:30 AM to 12:00 PM



Location:
Room No. 103
Seminar Hall

**E-CELL
SFIT**

Presents

Startup Saturday

**An interactive session involving student
entrepreneur, mentors
and established college startups.**



**Register: www.sfitcell.co.in
Applicants shall be selected by the E-cell.**

THE FIRST STARTUP SATURDAY WAS HELD ON 19TH SEPTEMBER 2015. THE OBJECTIVE OF THIS NETWORKING EVENT WAS TO ENCOURAGE A DISCUSSION BETWEEN BUDDING & EXPERIENCED ENTREPRENEURS, TO BRAINSTORM OVER POTENTIAL OPPORTUNITIES TO ENHANCE ONE'S STARTUP AND TO BE A PORTAL FOR RESOLVING INEVITABLE PROBLEMS FACED



by NEW STARTUPS. THE MENTORS CONSISTED OF MR. Uday WANKAWALA AND MR. GAURAV KARKHANIS.

MR. WANKAWALA HAS BEEN ACTIVELY ENGAGED IN UP ECO-SYSTEM AND NETWORK building IN INDIA. HE HAS PRIOR EXPERIENCE IN EDUCATION, ONLINE LEARNING, MARKETING AND PUBLIC RELATIONS DOMAIN AND SALES & MARKETING CONSULTANCY FOR IT, ITES START-UPS. HE IS CURRENTLY THE ASSOCIATE DIRECTOR AT UNLTD INDIA.

MR. GAURAV KARKHANIS HAS OVER 10 YEARS OF CORPORATE EXPERIENCE IN THE DIVERSE AREAS OF DATA WAREHOUSING - BUSINESS INTELLIGENCE & ADVANCED ANALYTICS, CONSULTING AND IT INFRASTRUCTURE. HE ALSO HAS A PASSION FOR CREATING POSITIVE IMPACT IN THE AREA OF EDUCATION WITH INNOVATIVE AND COLLABORATIVE PROBLEM SOLVING TOOL OF DESIGN THINKING. HE HAS BEEN THE FACILITATOR FOR SEED PROGRAM.

THE EVENT STARTED WITH A BRIEF INTRODUCTION OF THE MENTORS. THE EVENT WAS DIVIDED INTO TWO PARTS. THE FIRST HALF CONSISTED OF STARTUPS GIVING A 3-MINUTE PRESENTATION ABOUT THEM. THE SECOND HALF WAS AN INFORMAL DISCUSSION WHEREIN STARTUPS DISCUSSED THE PROBLEMS THEY ARE FACING WITH THE MENTORS.

FIVE STARTUPS ATTENDED THIS EVENT: STYLEDGE, WEQ CORP, FULLONDESI.COM, ROYAL NESHER AND CAKEMPOROS.

IT WAS ATTENDED BY ABOUT 20 STUDENTS WITH AN ENTREPRENEURIAL MINDSET.

THE SECOND STARTUP SATURDAY WAS HELD ON 16TH JANUARY 2016. THE EVENT FOLLOWED ITS PRESET FORMAT OF DISCUSSION. THIS INTERACTIVE SESSION OF STARTUP SATURDAY HAD SHRUTI AND CHETAS AS THE MENTORS AND WAS ATTENDED BY TWO STARTUPS, WEQ CORP AND FULLON DESI. THE TOPIC OF DISCUSSION WAS "DIGITAL MARKETING". IT PROVED TO BE A VERY ENRICHING SESSION FOR THE STARTUPS AS WELL AS THE STUDENTS.



3) SEMINAR ON ENTREPRENEURSHIP AND BUSINESS PLAN GENERATION

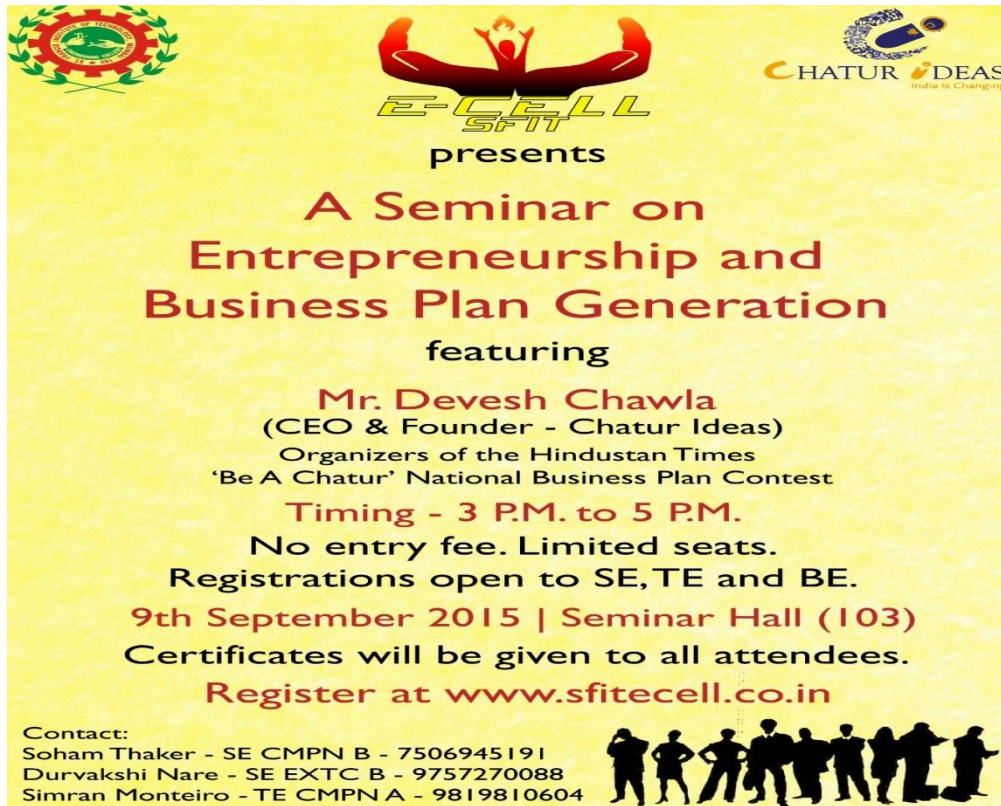

SFIT presents

**A Seminar on
Entrepreneurship and
Business Plan Generation**

featuring

Mr. Devesh Chawla
(CEO & Founder - Chatur Ideas)
Organizers of the Hindustan Times
'Be A Chatur' National Business Plan Contest

Timing - 3 P.M. to 5 P.M.
No entry fee. Limited seats.
Registrations open to SE, TE and BE.
9th September 2015 | Seminar Hall (103)
Certificates will be given to all attendees.
Register at www.sfitecell.co.in

Contact:
Soham Thaker - SE CMPN B - 7506945191
Durvakshi Nare - SE EXTC B - 9757270088
Simran Monteiro - TE CMPN A - 9819810604

This was held on 9th September 2015.

The objective of this was to brief the students about entrepreneurship and business plan.

The seminar was for SE, TE and BE students.

The speaker, Mr. Devesh Chawla (CEO and founder, Chatur Ideas), came in and shared his knowledge about the whole entrepreneurial concept. The seminar touched upon the basics of entrepreneurship and startup world. Mr. Chawla began with the very elementary topic of ideas and went down to the detailed explanation of a perfect business plan. He gave in effective inputs on how to create a plan with minute details. He also spoke about the necessity of mentors for a startup.

It turned out to be an interactive and hence productive session for the students. It was attended by 68 students.

Certificates were given to students at the end of the seminar



REPORT ON

E-YANTRA Robotics Competition 2014-15

E-YANTRA IS A PAN INDIA ROBOTICS COMPETITION DESIGNED FOR UNDERGRADUATE ENGINEERING STUDENTS AND FACULTY FROM ALL STREAMS, THIS YEAR THEY INCLUDED POLYTECHNICS AS WELL. IT IS ORGANISED BY IIT BOMBAY AND IS FUNDED BY THE GOVERNMENT OF INDIA. THIS YEAR E-YANTRA WAS HELD FOR STUDENTS ONLY.

INITIALLY THERE WAS A PRELIMINARY ROUND WHEREIN THE STUDENTS WERE ASKED TO MAKE TEAMS OF FOUR AND COMPETE IN AN ONLINE EXAM WHICH CONSISTED OF THE BASICS OF ALL STREAMS OF ENGINEERING AS WELL AS LOGICAL QUESTIONS. ELEVEN TEAMS FROM OUR COLLEGE PARTICIPATED, AND OUT OF THEM FOUR GO THROUGH TO THE NEXT ROUND. THIS YEAR DUE TO THE OVERWHELMING RESPONSE THE COMPETITION WAS DIVIDED INTO E-YANTRA AND E-YANTRA+, TWO TEAMS FOR EACH CATEGORY WERE SELECTED FROM OUR COLLEGE.

THE TEAMS WERE GIVEN TOPICS RANGING FROM FIREFIGHTING ROBOTS, CARGO SORTING ROBOTS AND HOSPITAL ASSISTANCE ROBOTS TO NAME A FEW. THE ENTIRE COMPETITION WAS DIVIDED INTO VARIOUS STAGES AND MARKS WERE AWARDED FOR EACH STAGE.

DURING THE COURSE OF THE COMPETITION THEY HAD THE OPPORTUNITY TO LEARN MANY NEW CONCEPTS SUCH AS CODING AN ATMEGA MICRO-CONTROLLER, LEARNING HOW TO PROGRAM A FIREBIRD ROBOT, IMAGE PROCESSING, INTERFACING VARIOUS SENSORS SUCH AS THE SHARP SENSOR, COLOUR SENSOR , LIGHT SENSOR ETC.

AT ST. FRANCIS INSTITUTE OF TECHNOLOGY TOTAL SIX TEAMS PARTICIPATED IN THE COMPETITIONS UNDER THE SUPERVISION AND GUIDANCE OF MR. ANSARI VAQAR. EACH GROUP WAS TRAINED BEFORE THE COMPETITION STARTS. OUT OF SIX TEAMS ONLY FOUR TEAMS GOT SELECTED BY THE SELECTION PROCESSES DESIGNED BY E-YANTRA IIT BOMBAY TEAM. THE DETAILS OF SELECTED TEAM MEMBERS AND THEIR INDIVIDUAL EXPERIENCE REPORT ARE ATTACHED ALONG WITH THIS SUMMARY REPORT.

REPORT VERIFIED BY

(MR. ANSARI VAQAR)

E-YANTRA TEAM LEADER AT SFIT



TEAMS SELECTED FOR E-YANTRA Robotics Competition:**TEAM eYRC#167 (FIRE FIGHTING):**

NAME	Class	Roll No.
NIPUN KHATRI	TE EXTC A	59
THERON MENEZES	TE EXTC B	09
JEVIN MENEZES	TE EXTC B	08
JIGAR MISTRY	TE EXTC B	12

TEAM eYRC#940 (CARGO SORTING):

NAME	Class	Roll No.
SIDDHESH GOTAD	TE EXTC A	47
HARSH JAIN	TE EXTC A	51
OMKAR CHAVAN	TE EXTC A	15
JAYKUMAR PATEL	TE EXTC	

TEAMS SELECTED FOR E-YANTRA+ Robotics Competition:**TEAM eYRC+ #1032 (QUALIFIED FOR STAGE 2):**

NAME	Class	Roll No.
VIKRANT FERNANDES	TE CMPN A	27
SHAMSAD KHAN	TE CMPN A	44
ADRIAN JOHN LASRADO	TE EXTC A	66
KEVIN D'SOUZA	TE IT B	6

TEAM eYRC+ #450 (NOT QUALIFIED FOR STAGE 2):

NAME	Class	Roll No.
SUSHANT SHETTY	SE EXTC B	58
KALIND KARIA	SE EXTC A	69
DHRITI IDDYA	SE EXTC A	57
VRUSHALI KHANVILKAR	SE EXTC A	73



REPORT OF TEAM eYRC#167

NIPUN KHATRI, JIGAR MISTRY, JEVIN MENEZES AND THERON MENEZES

ST. FRANCIS INSTITUTE OF TECHNOLOGY, TE EXTC

THE TEAM HAD PARTICIPATED IN THE E-YANTRA ROBOTICS COMPETITION (E-YRC) 2014-15 HELD BY IIT-B, POWAI AND WERE INSPIRED BY ASST. PROF. VAQAR ANSARI TO BE A PART OF THIS COMPETITION. INITIALLY, THE TEAM HAD TO GIVE AN ONLINE QUALIFYING TEST; THE COLLEGE SUPPORTED THEM BY PROVIDING THE COMPUTER CENTRE LAB EXCLUSIVELY FOR THE ONLINE TEST. APPROXIMATELY OUT OF 3200 REGISTERED TEAMS ALL OVER INDIA ONLY 260 TEAMS WERE SELECTED AND WERE ASSIGNED DIFFERENT THEMES. THERE WERE A TOTAL OF 5 THEMES AND THEY WERE ASSIGNED THE 'FIREFIGHTING THEME'.

THE COLLEGE HELPED THEM BY PROVIDING A ROOM AND A LAPTOP FACILITY FOR THE COMPLETION OF THE TASKS TO BE PERFORMED AS MENTIONED BY THE E-YRC. A TOTAL OF 4 TASKS WERE ASSIGNED. THE TEAM STARTED WORKING FOR THE COMPETITION JUST A WEEK BEFORE THE START OF SEM-5 UNIVERSITY EXAMS. AFTER THE EXAMS THEY CONTINUED WITH THE FURTHER TASKS, TASK 2 AND TASK 3, IN THE CHRISTMAS VACATION AND ALSO ON THE WORKING SATURDAYS. TASK 1 AND TASK 2 WERE BASED ON QUESTION-ANSWER SCHEME FOR THE TESTING AND ANALYSIS OF THE THEME. THEY SCORED 39/60 IN TASK1 AND 65.5/125 IN TASK 2. TASK 3 WAS THE SUBMISSION OF ORIGINAL AND BONUS VIDEOS OF THE THEME. THEY SCORED 1436 POINTS IN ORIGINAL VIDEO SUBMISSION AND 959 POINTS IN BONUS VIDEO SUBMISSION. THE FINAL TASK WAS THE SUBMISSION OF CODE AND THEY PERFORMED WELL IN IT BY SCORING 77/80.

THE COMPETITION GAVE THE TEAM A WIDE EXPOSURE AND EXPERIENCE IN ROBOTICS AND EMBEDDED SYSTEMS. THROUGHOUT THE COMPETITION TEAM WORK, TIME MANAGEMENT, TACKLING OF REAL-TIME PROBLEMS FACED BY THE FIREBIRD V WERE LEARNT.



REPORT OF TEAM eYRC#940

Siddhesh Gotad, Omkar Chavan, Harsh Jain and Jaykumar Patel

St. Francis Institute of Technology, TE EXTC

THE TEAM eYRC-940 WAS SELECTED FOR eYANTRA ROBOTICS COMPETITION 2014 AFTER HAVING EXCELLED IN THE ONLINE TEST ORGANIZED BY IIT BOMBAY. THEY WERE ONE OF 260 TEAMS WHICH QUALIFIED THE TEST OUT OF 3107 PARTICIPATING TEAMS ALL OVER INDIA. THE THEME ALLOTTED TO THE TEAM WAS "CARGO SORTING" TO BE IMPLEMENTED ON FIRE BIRD 5 RESEARCH PLATFORM.

THE THEME CARGO SORTING WAS HIGHLY CHALLENGING AND REQUIRED THE TEAMS TO DESIGN AN ALGORITHM WHICH WOULD SOLVE 110524 UNIQUE CASES THAT WERE POSSIBLE WITH THE ARENA PROVIDED AS A PART OF THE THEME. THE ALGORITHM FOR SOLVING THE CASES INVOLVED STUDY OF LABYRINTHINE CONCEPTS SUCH AS ARTIFICIAL INTELLIGENCE. DESIGNING OF THE ALGORITHM REQUIRED TWO WEEKS OF AUSTERE EFFORTS. SOME ERRORS IN THE ALGORITHM WERE OBSERVED DURING THE TESTING PERIOD WHICH WERE LATER DEBUGGED IN A PERIOD OF ONE WEEK.

THE TEAM GAINED AN ABOVE AVERAGE SCORE OF 146/185 IN THE FIRST AND SECOND TASKS CUMULATIVELY. HOWEVER, ALL THE TEAM MEMBERS BEING A PART OF ANOTHER ROBOTICS COMPETITION I.E. ROBOCON, WERE NOT ABLE TO CONTRIBUTE SUFFICIENT TIME FOR THE eYANTRA ROBOTICS COMPETITION. THE TEAM FAILED TO SUBMIT TASK 3 AND TASK 4 AS THE DATES OF THE TWO COMPETITIONS CLASHED. THE INABILITY TO SUBMIT THE TASKS ON TIME LOWERED THE CUMULATIVE SCORE AND THUS REDUCED THE POSSIBILITIES OF QUALIFYING FOR THE COMPETITION FINALE.

THE PROGRAMS WERE WRITTEN IN C-LANGUAGE ON ATMEL STUDIO 6 SOFTWARE. THE ATMEGA 2560 MICROCONTROLLER BASED FIRE BIRD 5 ROBOT WAS USED FOR TRAVERSING THE ARENA. THE ENVIRONMENT SENSORS USED ARE AS FOLLOWS:

1. COLOR SENSOR
2. SHARP DISTANCE SENSOR
3. LINE FOLLOWING SENSOR.

THE eYANTRA ROBOTICS COMPETITION WAS A TREMENDOUS LEARNING EXPERIENCE FOR THE TEAM IN THE FIELD OF MICRO-CONTROLLERS, ROBOTICS, EMBEDDED SYSTEMS AND ARTIFICIAL INTELLIGENCE.

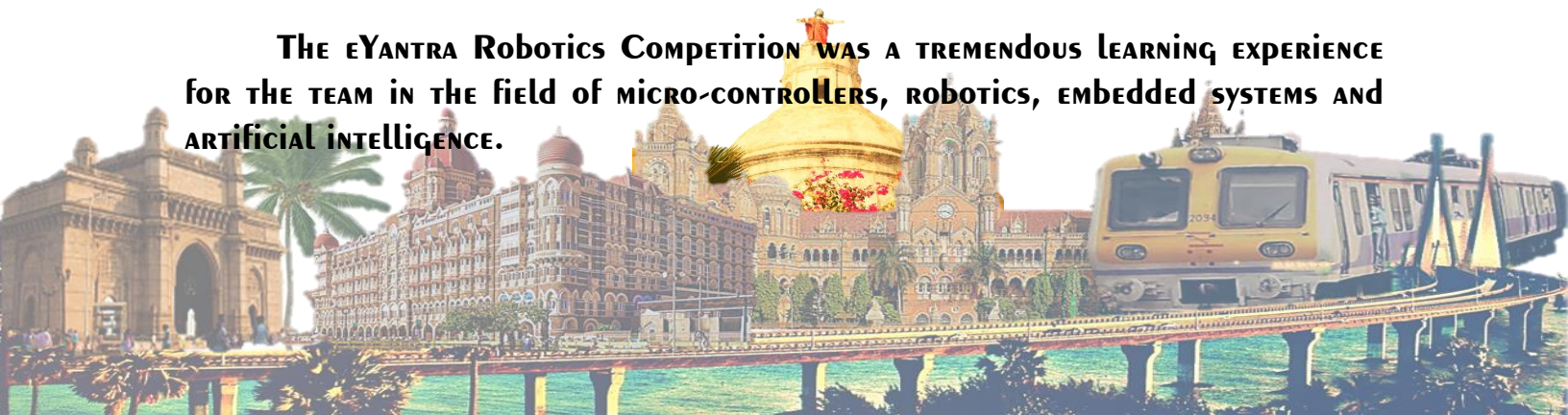

REPORT OF TEAM eYRC+ #1032

VIKRANT FERNANDES, SHAMSAD KHAN, KEVIN DSOUZA, ADRIAN JOHN LASRADO

ST. FRANCIS INSTITUTE OF TECHNOLOGY, TE CMPN, TE IT, TE EXTC

THE TEAM APPEARED FOR AN ONLINE EXAM IN THE INITIAL STAGE WHICH CONSISTED OF THE BASICS OF ALL STREAMS OF ENGINEERING AS WELL AS LOGICAL QUESTIONS. THIS YEAR DUE TO THE OVERWHELMING RESPONSE THE COMPETITION WAS DIVIDED INTO E-YANTRA AND E-YANTRA+, TWO TEAMS FOR EACH CATEGORY WERE SELECTED FROM OUR COLLEGE. THE TEAM WAS SELECTED FOR THE E-YANTRA+ COMPETITION.

INITIALLY THE TEAM WAS GIVEN BASIC IMAGE PROCESSING TOPICS DURING PRELIMINARY ROUND. THE TOPICS INCLUDED SETTING UP A CAMERA, CAPTURING VIDEO AND IMAGES USING THE CAMERA ETC. THE TEAM CLEARED THIS ROUND COMFORTABLY. IN THE NEXT ROUND AS THEY WERE AMONG THE SHORTLISTED TEAMS THEY WERE GIVEN A PROPER TASK. THE THEME ASSIGNED TO THEM WAS 'HOSPITAL ASSISTANCE ROBOT'. THEY RECEIVED A FIREBIRD V ROBOT AND XBEE MODULES FOR COMPLETION OF A PARTICULAR TASK. FOR THE COMPLETION THEY HAD TO LEARN IMAGE PROCESSING USING PYTHON AND OPENCV ALONG WITH PROGRAMMING THE FIREBIRD ROBOT ETC. OVERALL THEY SCORED RESPECTABLE MARKS IN ALL THE TASKS THAT WERE SUBMITTED. HOWEVER SINCE ENTIRE TEAM WAS PART OF THE ROBOCON TEAM AS WELL, THEY COULD NOT DEVOTE AS MUCH TIME TO E-YANTRA AS THEY WOULD HAVE LIKED, AND AS A RESULT OF THIS DID NOT MAKE IT TO THE TOP FIVE IN THE COMPETITION. THEY DID NOT FACE ANY DRAWBACKS DURING THE COURSE OF THE COMPETITION EXCEPT THE LACK OF PROPER SPACE TO WORK ON RESPECTIVE PROJECTS. THE TEAM THANKS COLLEGE FACULTY AND MANAGEMENT FOR GIVING SUCH A PLATFORM TO SHOWCASE SKILLS AT THE NATIONAL LEVEL AND FOR THE EXPOSURE THEY RECEIVED.



REPORT of TEAM eYRC+#450

Kalind KARIA, SUSHANT SHETTY, DHRITI Iddya, VRUSHALI KHANVILKAR

ST. FRANCIS INSTITUTE of TECHNOLOGY, SE EXTC

THE TEAM HAD PARTICIPATED IN THE e-YANTRA ROBOTICS COMPETITION (e-YRC) 2014-15 HELD BY IIT POWAI INSPIRED BY ASST. PROF. VAQAR ANSARI TO BE A PART OF THIS COMPETITION. INITIALLY, WE HAD TO GIVE AN ONLINE QUALIFYING TEST; THE COLLEGE SUPPORTED US BY PROVIDING THE COMPUTER CENTRE LAB FOR THE ONLINE TEST.

THE TEAM QUALIFIED THE TEST AND GOT SELECTED IN e-YRC+ COMPETITION WHEREIN WE WERE ASSIGNED THREE TASKS TO GET QUALIFY FOR MAIN e-YANTRA COMPETITION. WE WERE PROVIDED WITH THE WEB-CAM BY THE ORGANISERS.

IN TASK 0 – SETUP, THEY HAD TO INSTALL THE SOFTWARE: PYTHON, OPENCV AND NUMPY PROVIDED BY THE ORGANIZERS IN DVD. THEY HAD TO SUBMIT A VIDEO SHOWING THE EXECUTION OF THREE CODES: SHOWING GIVEN IMAGE, TAKING PICTURE FROM CAMERA AND TO TAKE A VIDEO WHICH WAS SUCCESSFULLY SUBMITTED BY THE TEAM.

IN TASK 1 – SENSING, THEY HAD BEEN PROVIDED WITH TEST IMAGES OF SNOOKER BALLS AND STICK WHEREIN THROUGH IMAGE PROCESSING THEY WERE SUPPOSED TO IDENTIFY THE BALL NUMBER TO WHICH THE STICK WAS POINTING TO. THE TEAM SUBMITTED THE TASK 1 BEFORE THE DEADLINE BUT WERE UNABLE TO COMPLETE THE TASK EFFICIENTLY DUE TO SEMESTER III UNIVERSITY EXAM WHERE THEY LOST THE POINTS AND GAINED JUST 11.25/50.

IN TASK 2 – PATH PLANNING, THEY HAD BEEN PROVIDED WITH TEST IMAGES OF GRID WITH A START AND AN END POINT WHERE USING DIJKSTRA'S OR A-STAR ALGORITHM WE HAD TO FIND THE SHORTEST PATH FROM START TO END POINTS. THEY TRIED THEIR BEST AND SUBMITTED BUT WERE UNABLE TO GAIN POINTS AND SCORED 8/40.

THE e-YANTRA ROBOTICS COMPETITION INCLUDED MANY NEW CONCEPTS LIKE IMAGE PROCESSING AND EMBEDDED SYSTEMS WHICH WERE VERY HELPFUL IN BUILDING THE ROBOTICS KNOWLEDGE OF THE TEAM. THEY WILL EAGERLY PARTICIPATE IN SUCH COMPETITIONS AND WOULD LIKE TO LEARN MORE.





Cakemporos

CAKE YOUR DAY SPECIAL

A STARTUP By OUR STUDENTS

AT CAKEMPOROS, OUR GOAL IS TO ENSURE THAT YOU CAKE YOUR DAY SPECIAL! WE BRIDGE THE GAP BETWEEN YOU AND LOCAL BAKERS BY DELIVERING THE CAKE OF YOUR CHOICE, FOR FREE, AT YOUR DOORSTEP. IT IS SOMETIMES TIRESOME OR FORGETFUL TO VISIT THE CAKE SHOP AND BUY A CAKE FOR YOUR NEAR AND DEAR ONES. WE EASE YOUR HUSTLE, BY BRINGING THE BAKERS ONLINE TO SERVE YOU YOUR FAVOURITE FLAVOUR. MUMBAI'S ONLINE PLACE TO BUY WIDE RANGE OF CAKES FROM BIRTHDAY CAKES, ANNIVERSARY CAKES, WEDDING CAKES, PRINTED CAKES, 3D CAKES, ASSORTED CUPCAKES AND LOT MORE.

CAKEMPOROS IS A START-UP FROM ST. FRANCIS INSTITUTE OF TECHNOLOGY, AN IDEA WHICH CAME UP IN THE INNOVATIVE MINDS OF A BUNCH OF ENGINEERS. OUR CLASS HAD A TREND OF CELEBRATING BIRTHDAYS EVERY MONTH. A BIG HASSLE WE FACED WAS GETTING THE CAKES TO THE CLASS IN A VERY SHORT SPAN OF TIME. A MERE 45 MINUTE BREAK WAS CERTAINLY NOT ENOUGH FOR US TO GO ALL THE WAY TO THE CAKE SHOP, SELECT A GOOD CAKE, WHICH SOMETIMES WASN'T AVAILABLE INSTANTLY, AND GET IT BACK IN AN AUTO-RIKSHAW, DESPITE RAINS, HEAT OR COLD. OWING TO THE DISCOMFORT AND TIME CRUNCHES, THERE WAS A CONSTANT NEED OR A DESIRE THAT A CAKE COULD WALK TO OUR CLASS BY ITSELF AND OUR JOB WOULD BE REDUCED GREATLY. INCIDENTALLY, WE HAD A SUBJECT IN OUR SECOND YEAR COMPUTER SCIENCE COURSE TERMED "STRUCTURED AND OBJECT ORIENTED ANALYSIS AND DESIGN" WHICH COMPRISED OF DESIGNING A SYSTEM. SINCE HOSPITAL, RAILWAY AND OTHER BANAL MANAGEMENT SYSTEMS WERE TAKEN UP ALREADY, WE DECIDED ON TAKING UP CAKEMPOROS AS OUR GROUP TOPIC.

BY THE END OF 2014, VIKRAM SIR PUSHED US INTO GETTING A VENTURE RUNNING WHICH OBVIOUSLY, WOULD IMPART IN US, TONNES OF EXPERIENCE. ON SHARING THIS IDEA WITH HIM, HE READILY PROPOSED TO MENTOR US AND SO WAS THE FOUNDATION FOR CAKEMPOROS LAID.



Nikhil Shirsath, our senior, had some experience in the technical zone. When our friends went out for parties, we worked on our business plans and strategies. After a series of technical, financial and managerial difficulties, Cakemporos delivered its first cake on March 12th, 2015. Ever since, we have seen progress in terms of sales, finance and market acceptance. Being a new idea in the local market, we did not receive any help in the form of investments; yet, we led from the front and made sure this idea was a success, a reality in a very short span of time. We didn't lose pride by delivering the cakes ourselves when we were short on finances to afford delivery boys. We have successfully acquired most of the western belt of Mumbai and working on expanding our scope all over the city, soon to be over India. *fingers crossed*

Shruti Patil, someone with an experience in digital marketing, joined us in November 2015. We are currently working on beating the most difficult challenge- Sales, but we believe, with confidence and hard-work, everything will be achieved.

A word of advice for our fellow juniors would be- Believe in your idea and work hard to achieve it. Managing a business and simultaneously not getting a KT is not a difficult task. Time management is what you need and learn to compromise.

***This was possible only because of the guidance of Vikram sir and the support from our lovely customers.**

-The Cakemporos team. (Yash Gokhale, Sania Furtado, Nikhil Shirsath, Shruti Patil)

www.cakemporos.in

#CakeYourDaySpecial!



RESEARCH & DEVELOPEMENT CELL

THE IMPORTANCE OF RESEARCH AND DEVELOPMENT IS IMMENSE IN EVERY FIELD. OUR R & D CENTRE AT ST. FRANCIS INSTITUTE OF TECHNOLOGY HAS BEEN PROVIDING OPPORTUNITIES TO BOTH STAFF AND STUDENTS TO PURSUE THEIR GOALS IN DIRECTION OF INNOVATION AND RESEARCH. SINCE ITS INCEPTION, OUR R & D CENTRE HAS COMPLETED TWELVE PROJECTS. WE RECEIVED TWO MINOR GRANTS IN THE ACADEMIC YEAR 2013-14 AND SIX MINOR GRANTS IN THE YEAR 2014-15 FROM THE UNIVERSITY OF MUMBAI. WE ARE AIMING FOR SEVEN MINOR GRANTS IN THE YEAR 2015-16. WE HAVE BEEN WORKING WITH IIT BOMBAY IN THEIR RESEARCH PROJECT BASED ON DEVELOPING AAKASH TABLETS. IN THIS REGARD, WE HAVE RECEIVED RESEARCH GRANTS FROM IIT BOMBAY FOR FOUR RESEARCH PROJECTS. WE ARE ALSO, IN PROCESS OF UNDERTAKING CONSULTANCY PROJECTS IN ASSOCIATION WITH INDUSTRIES.

FOR THE DEVELOPMENT OF ROBOTICS LABORATORY OF OUR COLLEGE, OUR FACULTY MEMBERS PARTICIPATED IN WORKSHOP UNDER THE GUIDANCE OF E-YANTRA ROBOTICS TEAM OF IIT BOMBAY. AS A REMOTE CENTRE FOR WORKSHOPS ORGANIZED BY IIT BOMBAY AND KHARAGPUR, OUR INSTITUTE HAS BEEN PLAYING A MAJOR ROLE IN IMPLEMENTING THE OBJECTIVE OF THE NATIONAL MISSION ON EDUCATION THROUGH ICT FUNDED BY MHRD, GOVERNMENT OF INDIA. WE HAVE ORGANIZED MORE THAN FIVE WORKSHOPS FOR TECHNICAL DEVELOPMENT OF OUR FACULTY, IN ASSOCIATION WITH IIT BOMBAY AND KHARAGPUR. WE ARE DOING OUR BIT IN TERMS OF PUBLICATIONS AS WELL. OUR IN-HOUSE ANNUAL TECHNICAL MAGAZINE 'SANSHODHAN' PROVIDES AN INVALUABLE PLATFORM TO BOTH STUDENTS AND STAFF TO SHOWCASE THEIR RESEARCH CAPABILITIES. WE ALSO PUBLISHED A R&D INFORMATION BROCHURE 'RESEARCH' IN 2014-15 WHICH ELABORATES ON RESEARCH INTERESTS OF OUR FACULTY. THROUGH THIS WE AIM TO FOCUS ON CONSULTANCIES AND RESEARCH PROJECTS FROM SOCIETY AND INDUSTRIES.



Dr. Ak Sen



Dr. Uday Khot

RadLab Report

1. AUTOMATIC PLANT IRRIGATION SYSTEM

Objective:

To reduce wastage of water and to protect plant and soil from degradation caused due to improper irrigation methods

Mentor:

Flavian Pegado, Mithil Raut, Dr. Vikram Shete

Description:

Automatic plant irrigation system is designed to reduce human intervention in the process of irrigation. By reducing the human intervention we can ensure elimination of improper irrigation. This will lead to conservation of water, ensure plant health and reduce wastage of minerals in soil. It will also save time and reduce human effort. It will promote technology in the field of agriculture

Process:

The system is designed to continuously check the moisture content of the soil and accordingly decide whether the plants need water or not. If the moisture content in the soil falls below a set amount it switches an electric valve which allows the flow of water. This valve may be connected to water line or storage.

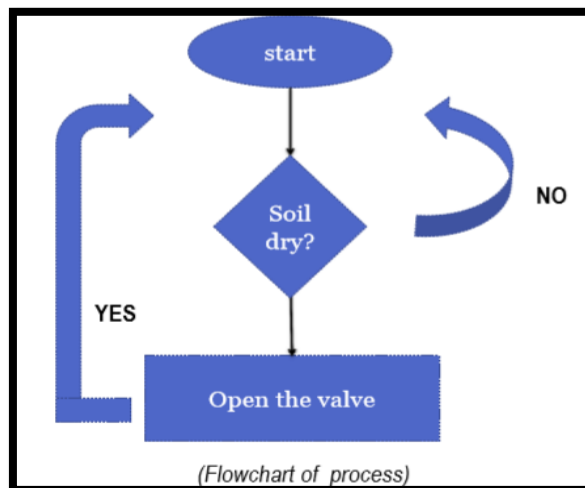

Technical specification:



- Conducting probes – to measure electrical conductivity
- Resistors- to form voltage divider circuit and to prevent LEDs from damaging
- Capacitors- to reduce noise signals
- Analog to digital converter(ADC)
- Relay switch
- 230V AC solenoid valve

The valve used is a 230V AC solenoid valve and the controller works on 5V DC supply.

Conducting probes are used as sensors which provide high precision. The system consumes less power as it is on standby most of the time till the soil has adequate moisture.

Stakeholder Mapping:

Primary stakeholders: farmers, garden owners, flat owners having balcony plants etc.

Secondary stakeholders: irrigation solution providers

Secondary research

- Sensors can be used to sense various parameters of soil and water. Parameters include moisture, temperature, pH value etc.
- Various wireless technologies can be used to transmit these information to a remote location or any other system.
- Prior warnings and real time data with effective solutions can be given to the farmers using mobile and cloud technology.

Future scope:

The technology can be developed to find various parameters including pH, salinity, electrical conductivity, temperature, moisture and essential elements like N,P,K in the soil. This information can be recorded and stored using cloud technology to provide real time data. A system can be developed which can process the available data and provide solution and suggestion based on the current condition of the soil

By Faizan Shaikh



2. INFINITY: LEARNING TOOL FOR Kids

Infinity is designed to make understanding electronics easy for kids. Designed as a modular toy that can be assembled and connected in different ways to make circuits, *Infinity* eliminates the complexity of handling small components and gives them an inviting look and feel to play with.

Electronics and kids:

Curiosity is the spark that drives all innovation. Kids are the most curious creatures around us.

But they can't play with electronic components because:

1. The components are small in size. Hence, they are difficult to handle.
2. Fear of electric shocks.
3. Pointed ends hold the potential of injury.
4. Lack of proper understanding about the components.

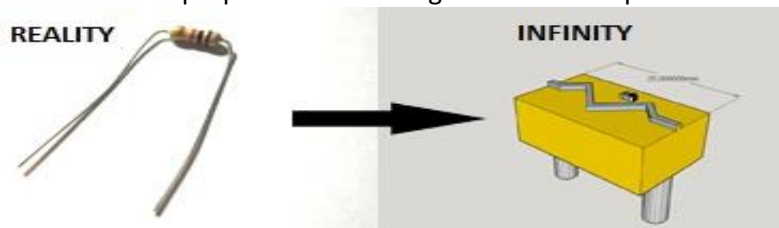

Fig 1: Normal resistor and Infinity kit resistor

How will Infinity help?

With infinity the electronic components are embedded inside a plastic mold containing blunt edges. These are easy to connect and disconnect. The problem of soldering is eliminated. Infinity components are kid friendly, attractive, portable, light in weight and tough. Infinity also includes a manual containing all the animated pictures of circuit diagram which are understandable for a kid.

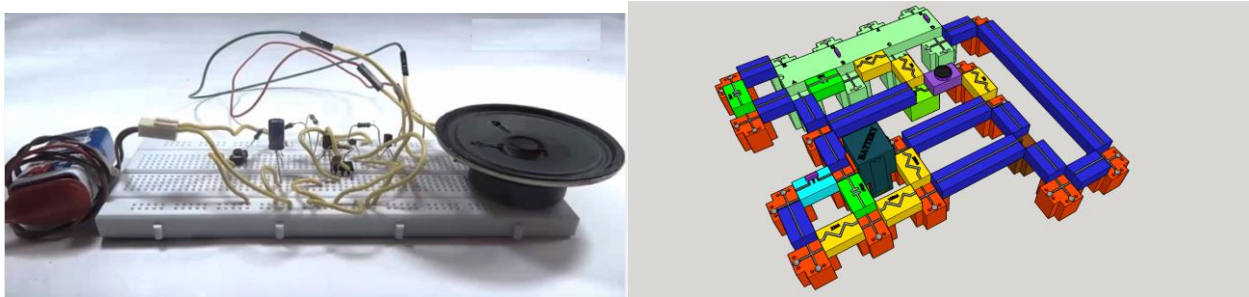

Fig 2: Comparison Between real circuits and infinity circuit.

Future and marketing

Infinity will expose kids to technology. They will learn it out of curiosity and fun. This will foster their creativity. As a nation we need our younger generations to appreciate technology as a part of their life and not just as job fetching skill. Infinity will be positioned as an educational toy and can be retailed in stores and one commerce website. Infinity targets school kids in the age group 10- 15 years.

By Soham Thaker, Gaurang Date, Prachi Lad, Dev Shah, Charitra Attarde.



3. PRECISION FARMING WITH UNMANNED AERIAL VEHICLES AND WIRELESS SENSOR NODES.

Agriculture is the largest livelihood provider in India. However, productivity of the farmland remains drastically low due to heavy dependence on uncertain rains, lack of irrigation, marginal use of mechanization etc. Monitoring farms and tending to produce effectively is a laborious task and involves large human presence. Decision making is totally based on the experience of the farmer and not on scientific data. In order to increase productivity of farms, it is necessary to use technology which not only gives accurate data but also is cost efficient.

In this work we propose the deployment of wireless sensor nodes in the farm. The idea is to gather under-soil and atmospheric data from different locations of a farm. This ensures that data collection is consistent and fair. Sensor nodes can collect a variety of data such as humidity, temperature, soil pH etc. These nodes could be deployed in a wireless sensor network (WSN) configuration as well. Such configurations are susceptible to data transfer bottle neck with a single point of failure at the base station. Besides, such networks are also expensive. In order to overcome this problem, we propose a hybrid solution in an ingenious and cost effective manner.

Our system consist of two components namely

- Wireless sensor nodes
- An Unmanned Aerial Vehicle to collect data from the wireless sensor nodes.

The WSN would be used to sense various soil parameters such as humidity, temperature, soil pH and Base Cation Saturation Ratio (BCSR) that are essential for the productivity of the farms. This network would include number of identical stationary nodes, placed at a specific distance from each other, that consist of sensors. The entire circuit would be encapsulated in an enclosure for protection.

The sensed data will be retrieved in a predefined manner by a UAV. A ‘wake up’ mechanism will be used by the drone to indicate its arrival to the sensor node. This will allow the sensor node to ‘sleep’ and conserve battery. We will develop a handshake mechanism to facilitate wake-up and data transfer between the UAV and the sensor node as soon as the UAV is within range of the node. The UAV will fly over all nodes using onboard GPS module and collect data from each of the nodes. UAV will return to its docking station and upload retrieved data onto the servers. Further analysis can be done on the server as per the farmers needs and decision making can be facilitated. Data on the sensor nodes will be flushed periodically.

This project will ease the process of analyzing the farm and take the necessary actions to increase the productivity of the farmland.

The WSN-UAV system can be employed for plantation industries, vineyards, floricultures or the companies that own farms for their products. At an individual level, this service can be provided on a rental basis.



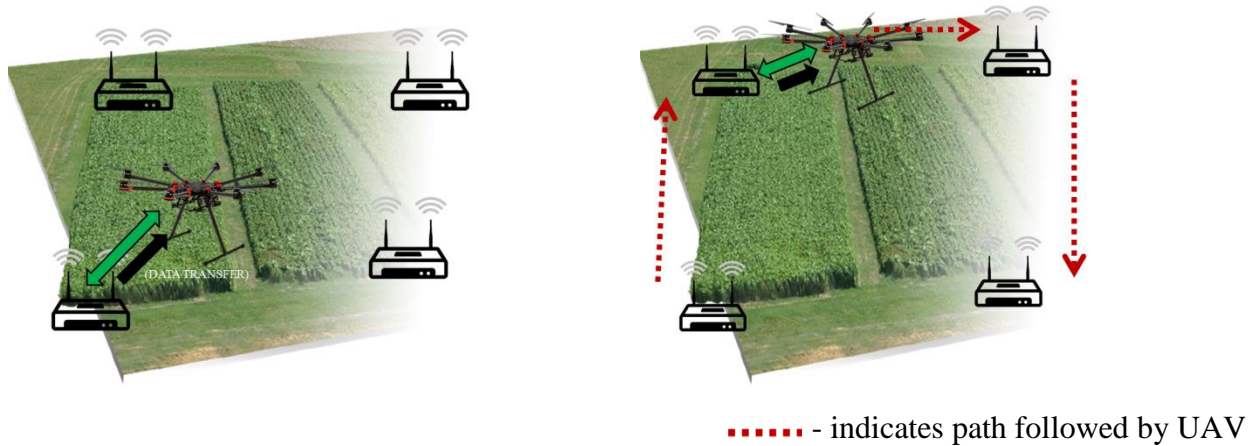

Fig. 1

Fig 2

Fig 1 depicts a field with 4 nodes. The drone would connect to one node at a time. After connecting, the sensor node will transfer the data stored in it. The drone then moves towards the other node and acquires data from it in the same manner as shown in fig 2.

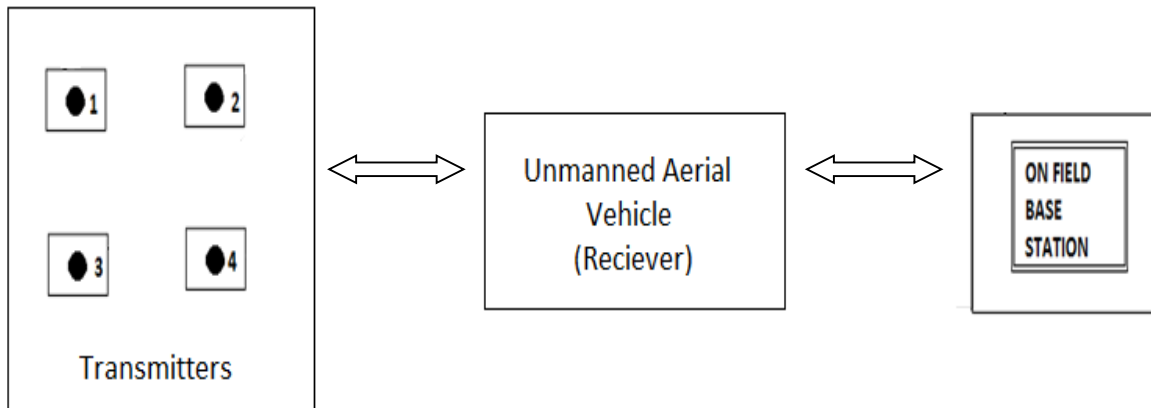
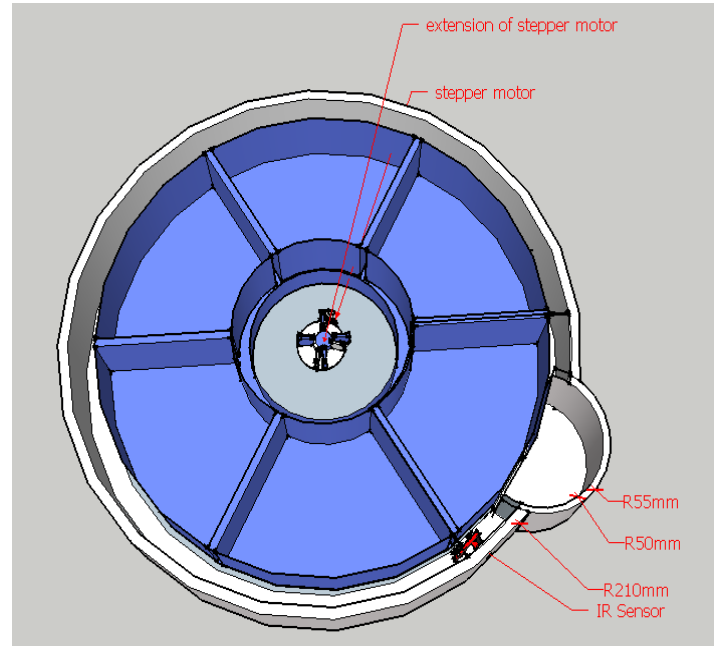
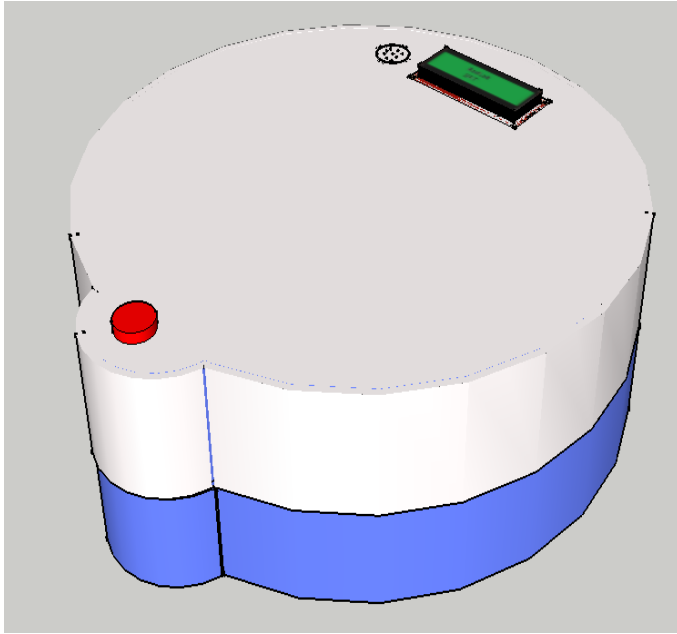

Fig.3: Block diagram of the proposed solution

By,
 Drishti Rao (SE EXTC B), Jagdish Chaudhary (SE IT A),
 Nachiket Makwana (SE IT B), Varun Maniar (SE CMPN A)



4. INTELLIGENT TABLET DISPENSER (ITD)



INTRODUCTION

Rahul's grandfather is a Parkinson's patient. He needs to take around 4-5 doses everyday of 10 different types of medicines. Every week, Rahul has to make the dose for the next week as well as remind him to take the dose. He is always worried about his grandfather's medications whether he takes them on time or not. Meanwhile in an old age home there are more than a dozen senior citizens that are not so fortunate. It's very difficult for them to remember the name and time of medicines. These are some problems arising amongst the senior citizens, hospital patients, bedridden and paralyzed patients all around the world. Being able to properly manage medications can be a deciding factor for seniors wishing to stay in their home. Common medication mistakes like missing doses, taking incorrect amounts, or taking medicines at the wrong times could lead to unnecessary doctor or hospital visits, illness and even death. Intelligent Tablet Dispenser (ITD) makes independent living possible by automating the pill taking process.

WORKING

The dispenser is easy to set up and even easier for seniors to use. Typically it's the caretaker who loads the machine with medications. When adding a new medication simply type the name, dose



and what scheduled time to take the medication. When it's time for a dose the machine will sound a visual as well as audible reminder. Patients can simply press the release button and collect their medicines from the dispense cup. Alert notifications such as messages and emails are sent to the caretakers if the patient misses a dose, power outage, error in dispensing as well as reminders to refill when medications are running low, thereby providing plenty of time to get prescriptions refilled. ITD can store a 30 day pill supply and manage up to 6 different medications. It can be used by multiple patients. It allows individuals to set reminders and manage alerts for non-pill medications such as insulin injections, inhalers, eye-drops, etc. This product reduces the high percentage of human error when taking medication. No more counting pills and sorting pills for each dose.

ITD Has The Following Features:

- Convenient loading of medication: It can store a 30 day supply of 6 different medications a day.
- Easy to set schedule when adding a new medication.
- Visual and audible reminders with instruction when dispensing a medication.
- Medicine is dispensed with the press of a button. The reminder gives alert for 30 min until the button is pressed. After which the caretaker as well as patient gets notification alerts to take the medication.
- Caretaker gets alert messages and email notifications for missed doses, required refills, dispensing error.
- It can dispense multiple doses throughout the day.
- Locked cabinets with password protection to restrict access.
- Easy access dispense cup.
- All compartments are covered and sealed, which makes the device tilt proof.
- Portable design.
- Optional early dose feature.
- It can be used for multiple patients.
- Alert message and reminders for non-pill medications.

REFERENCES

1. Philips pill dispensing service.
2. 'MedaCube' by PharmAdva.

-By Neha Nagarkoti (SE EXTCA) Ankit Shahu (SE CMPN B)
Yash Dedania (SE IT A) Tanvi Sinha (SE EXTC B)



STUDENT CHAPTERS & CLUBS





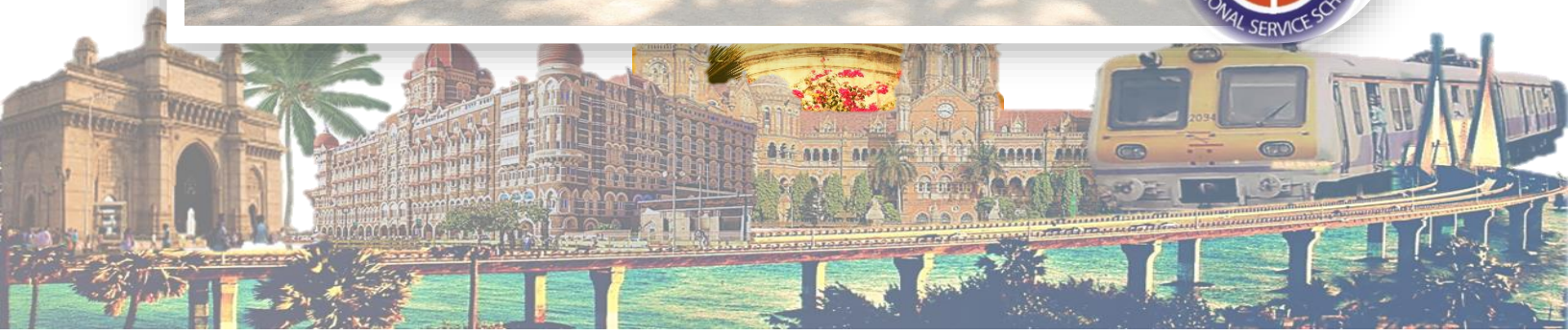

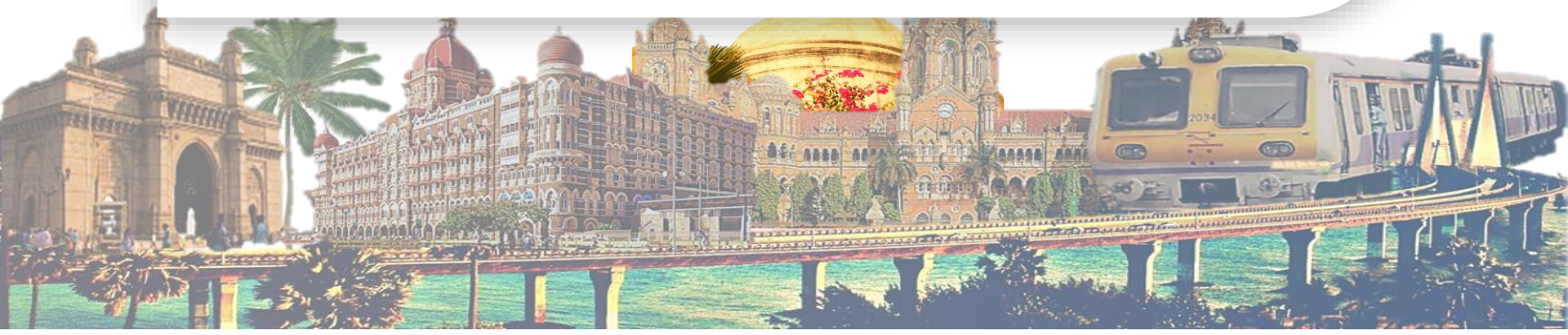



BASKEtBALL TEAM



FOOTBALL TEAM





THROWBALL TEAM



CRICKET TEAM





L-R: - SANTOSH, KUNAL, BRANDON

**Special Thanks
To The Photography Team**





Kaisa :
2009/01/18